



reddot award 2017
winner



BIRTHING BED AVE2

UN-PACKING MANUAL
INSTRUCTION MANUAL

D9U004PPB-0101
Version: 08
Publication Date: 2022-06



1 UN-PACKING MANUAL	10
2 OVERVIEW OF BASIC PARTS	18
2.1 Overview of basic versions	19
2.2 Overview of standard colour versions	19
2.3 Safety.....	19
3 FUNCTION	20
3.1 Interaction	20
3.2 General instructions	20
3.3 Application environment 5.....	20
4 INTENDED USE	21
4.1 User population.....	21
4.2 Contraindications	21
4.3 Operator.....	21
5 GENERAL SAFETY	22
5.1 Electromagnetic compatibility.....	23
5.2 Mechanical safety	26
6 SETTING THE PRODUCT	27
6.1 Transport, braking	28
6.2.Transport.....	30
7 OPERATING THE BED	32
7.1 Side rails	32
7.1.1 Description of the control panel for the woman in childbirth	32
7.1.2 Adjustment of the handle in inactive position.....	33
7.1.3 Adjustment of the handle in active position	33
7.2 Side control panel	34
7.3 Manual setting of the CPR	36
7.4 Electric setting of Trendelenburg	38
7.5 Setting of the foot section.....	39
7.5.1 Folding/unfolding	39
7.5.2 Lifting/lowering.....	41
7.5.3 Tilting up/down	43
7.6 Adjusting the leg rests.....	44
7.6.1 Gynaecological position.....	45
7.6.2 Foot rest position	46
7.6.3 Maximum bed surface position.....	49
7.6.4 Turning the leg rests sideways	50
7.6.5 Leg rest tray adjustment	51
7.6.6 Leg rest tray height adjustment	53
7.6.7 Leg straps.....	54
7.7 Backup Battery.....	55
7.8 PPB-068 Grab handles, detachable (R/L).....	56
7.9 PPB-013 Grab handles, non-detachable, foldable (R/L)	56
7.10 Holder of infusion stand	58
7.11 Equipotential coupling	58









7.12 Exchangeability of the upholstery	59
8 ACCESSORIES	60
8.1 PPB-062 Cable hand controller.....	60
8.2 PPB-071 Supporting bar	61
8.3 Under carriage light.....	61
8.4 SB-B-00322 Infusion stand, stainless steel, telescopic.....	62
8.5 PPB-064 Eurolath along the seat section.....	62
8.6 PPB-060 Rear bed-head.....	63
8.7 GKB-076 Doctor's chair (ergonomic)	63
8.8 ZK-05.X Doctor's chair	63
8.9 PPB-069 Front bumper on foot section	64
8.10 PPB – 066.01 Upper mattress (for 100 mm cushioning)	64
8.11 PPB – 070.01 Upper mattress (for 130 mm cushioning)	64
8.12 PPA-010 Tray on the swinging holder.....	65
8.13 Nurse call.....	66
8.14 PPB-077 Front bumper fitted on the leg rest (R/L).....	67
8.15 Head rest	67
8.16 Bowl PPB-034.....	68
8.17 DB-B-00194 Instrument tray	68
8.18 PPB-088 Protractor of the seat part, PPB-098 Protractor of the back part....	69
8.19 PPB-097 Bracket for oxygen bottles	70
8.20 S4-04642A Patient card.....	71
8.21 Baby plate	72
PPB-074 Version with mattress	73
8.22 USB cell-phone recharger.....	76
9 CARE.....	78
9.1 Cleaning and disinfection	78
9.1.1 Cleaning the bed	79
9.1.2 Recommended disinfection (disinfectants for wiping).....	81
9.1.3 How to properly coat bed with hospital bedding	82
9.1.4 How to properly coat bed with Disposable bed sheets	83
9.1.5 How to properly coat bed with terrycloth.....	84
10 MAINTENANCE.....	85
10.1 List of error, malfunction and generated messages	86
10.2 Technical parameters.....	87
10.3 Electrical parameters	88
10.4 Attached parts of product.....	89
10.5 Transport instruction, Storage instruction.....	90
10.6 Service and repairs	91
11 ENVIRONMENTAL PROTECTION AND LIQUIDATION OF THE PRODUCT	92
12 LIST OF AVAILABLE EQUIPMENT	93













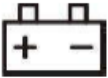



Introduction













Please read carefully the whole instruction manual, which is designed to familiarize you with the correct use and the parameters of your new birthing bed. Please always follow the instructions contained in this manual and use the bed only in accordance with these instructions.



Please keep these instructions near the bed throughout its operation. Every person operating the birthing bed AVE2 must read and understand the contents of these instructions.

Very important information is marked throughout the manual by the following symbols:

Pictogram	Meaning
	EU legislation compliant product
	The upholstery meets the requirements on resistance to ignition according to BS 7176 in the Medium hazard category. The upholstery meets the requirements of BS EN 1021-1, BS EN 1021-2, BS 5852 – resistance to ignition sources 5
	Warning: Dangerous electric voltage
	Warning: Caution
	This symbol introduces any information that may help you avoid operative problems
	Type B applied parts
	Serial number
	Type number explanation
Int x/y	Marking of intermittent operation, i.e. if the product has been continuously operated for time period “x”, then it must rest idle for time period “y”. For example, int 10 / 20 means that after 10 minutes of continuous use /positioning the product must be out of use/not positioned for 20 minutes
IP	Design protection against water ingress,

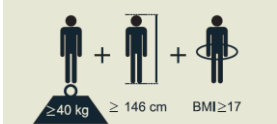
	hazardous contact and the ingress of foreign objects according to IEC 529
	Safe working load
	Maximum patient weight
	Overall product weight
	Battery marking
	Manufacturer
	Date of production
	Follow the instructions manual
	Safety isolating transformer
	Medical device internal use
	Thermal protection of the transformer
	Equipotentiality
	Packaging material: "Keep dry"
	Packaging material: "Fragile!"
	Packaging material: "This side up"
	Temperature limitation
	Transportation marking: „Relative air humidity“.
	Transportation marking: "Air pressure".

	<p>Marking according to the directive EC 2002/96/EC (Directive on disposal of old electric and electronic appliances). Symbol for: "Do not dispose of the product into communal waste. Use special collection points for old electronic appliances."</p>
	<p>Terry cloth sheet The product must not be ironed</p>
	<p>Terry cloth sheet Do not dry clean</p>
	<p>Terry cloth sheet Maximum temperature of 60°C Normal setting</p>
	<p>Terry cloth sheet Do not bleach</p>
	<p>Terry cloth sheet May be tumble dried Normal temperature, max. 80 ° C</p>
	<p>Cardiopulmonary resuscitation (CPR)</p>
	<p>Safe working load of foot section</p>
	<p>Warning: No sitting on leg rest Safe working load of leg rest</p>
	<p>Warning: Do not push or pull infusion stand</p>
	<p>Warning: Never step on the lifting column cover in movement. The space is indicated with a caution sticker.</p>
	<p>Warning: Do not place objects in this area</p>
	<p>Warning: Do not place objects on this cover</p>
	<p>Designation of birthing bed for adult</p>

	<p>MEDICAL DEVICE (compatible with Medical Device Regulation)</p>
	<p>UNIQUE DEVICE IDENTIFIER</p>
	<p>Caution or Warning:</p> <p>The power cable shall always be clamped on the selected place of the bed using a plastic hook as is recommended on picture!</p> <p>Follow the instructions manual!</p>



Abbreviation	Meaning
LED	Light emitting diodes
VA	Power intake unit
IT	Information technology
PC	Personal computer
dB	Sound intensity unit
hPa	Pressure unit
Hz	Frequency unit in the SI system
EMC	Electromagnetic compatibility
HF	High frequency
ME	Medical equipment
CISPR	International Special Committee on Radio Interference
SWL	Working load limit

Acoustic signalling	
Sound	Meaning
One short acoustic signal when pressing the button.	Key lock activated
Intermittent acoustic signal when pressing the Trendelenburg button.	The underfoot part is neither in the 'parked' nor in the 'active' position.
Intermittent acoustic signal when pressing the positioning button.	The battery charge is lower than 1/3 of its capacity.
Intermittent acoustic signal when pressing the positioning button.	Motor current protection activated.
Intermittent acoustic signal even without pressing any button.	Failure of the controller.
Continuous sound when simultaneously pressing the up and down column buttons.	Motor current protection resetting.
2x short acoustic signals when the trendelenburg key is pressed	Position switch fault in the column. Positioning into Trendelenburg will run in emergency mode.

Production label – explanation of symbols:

1 BORCAD MEDICAL
BORCAD Medical a.s.
Fryčovice 673, 739 45
Czech Republic
www.borcadmedical.com
Made in Czech Republic

2 AVE2
REF **PPB-A A 30**
SN **PPB1869**
MODEL: 4BCPPB-3AL00BC

3 2020-03-19

4 UDI
(01)8596307001168
(11)200319
(21)PPB1869

5

6

7 V: 220-240V, 50/60Hz
P: max. 570VA
int. on/off: max 2/18 min
IP X4 Class:I

8

9 = 240 kg
= 255 kg
= 245 kg
MD
CE

1	Address of Manufacturer
2	Type of product, serial number
3	Manufacturing Date (Year-Month-Day)
4	DI (Device Identifier)/ GTIN (Global Trade Item Number)
5	PI (Product Identifier)
6	2D Bar Code (GS1 DataMatrix) DI+PI=UDI
7	Electrical Specification
8	1D Bar code GS1-128 (Serial number)
9	Symbols



Please address any potential queries to the authorized representative or directly to the Manufacturer BORCAD Medical a.s.

1 UN-PACKING MANUAL

Inspection of the consignment after delivery

Do not unpack and/or accept the consignment if the package has any visual damage! If so, issue a complaint.

Personal qualification

The persons authorised for installation and putting into operation of the product, i.e. those trained by BORCAD Medical a.s.

Personnel required for unpacking and installation

Minimum two persons.

Anticipated time

Anticipated time of unpacking is 30 minutes, anticipated time of installation is 30 minutes.

Necessary tools and materials

Philips screwdriver, scissors / knife, 2x polystyrene tracks, included in the packaging.

Required working space

When unpacking, overall bed dimensions should be considered. Recycle used packaging materials. We recommend unpacking and installation be made in the goods receiving department. For unpacking operations, observe minimum 0.8m on the sides of the pallet and minimum 2.6m in front of the pallet (i.e. minimum space for unpacking 2.8x5.2m).

Sequence of instructions

Cut the pockets with the user guide to the bed open carefully and take them out. Then remove the box.



Cut the plastic bag open carefully; ideally around the bottom edge of the pallet and remove the polythene from the chair including the bottom of the box.



Cut the foil which holds the power supply cable carefully; plug the cable in. Then cut the band around the box containing the bed equipment and remove the bar (if contained in the package). It is recommended to put the back of the bed in an upright position (60°) in order to access the box easily.



Take out all the equipment from the box item-by-item. Bowl if included in the packaging.

Remove the other container from the pallet, so that the upper part is free.

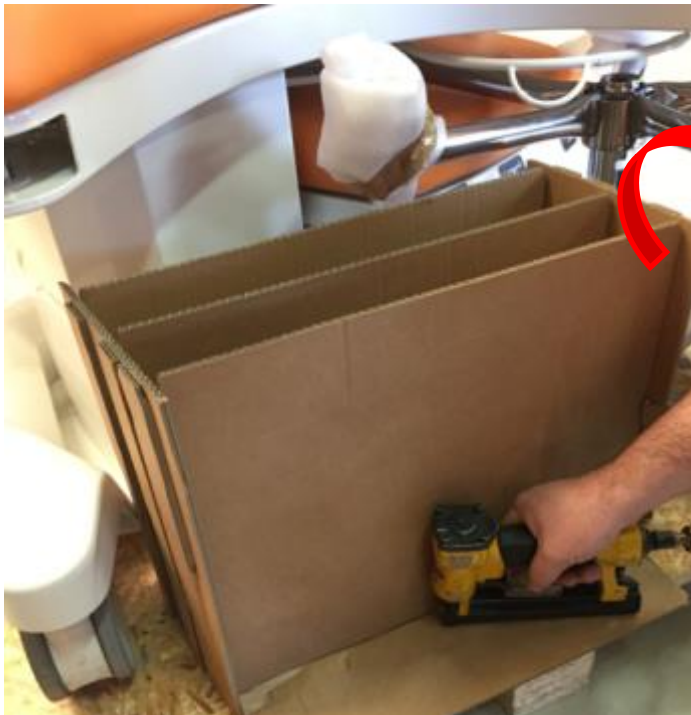

Unscrew the medical chair (if it is included in the package). It is recommended to put the bed to a higher position.



Cut and pull out the tape, loosen the underfoot part



Remove plastic plug from the locking element.

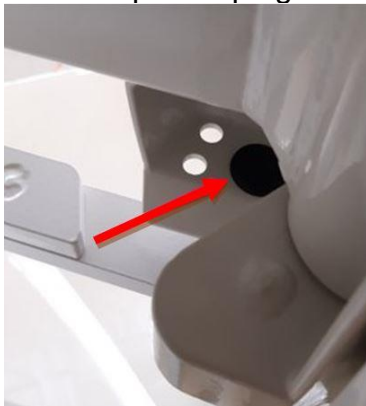

Remove the rest of the packaging material off the bed.

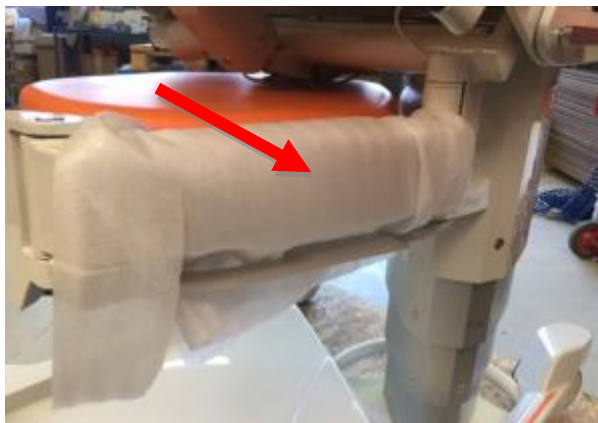

Make sure that all wheels are facing forward alongside the longer part of the pallet and lock the wheels to move in a straight line.

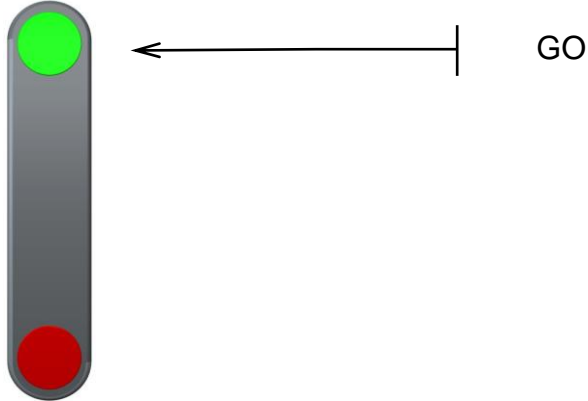

Cut all plastic tapes that hold the basic frame onto the pallet.



Put two polystyrene ramps to the edge of the pallet.



Carefully push the bed so that it gets from the anchoring wedges to the pallet and then move it down using the ramps.



Back-up battery connecting

With regard to the possibility of unwanted switching on of AVE2 upon packaging, transport and unpacking, the battery is normally disconnected from the equipment. The following pictures show how to connect the battery.

Remove the undercarriage cover.

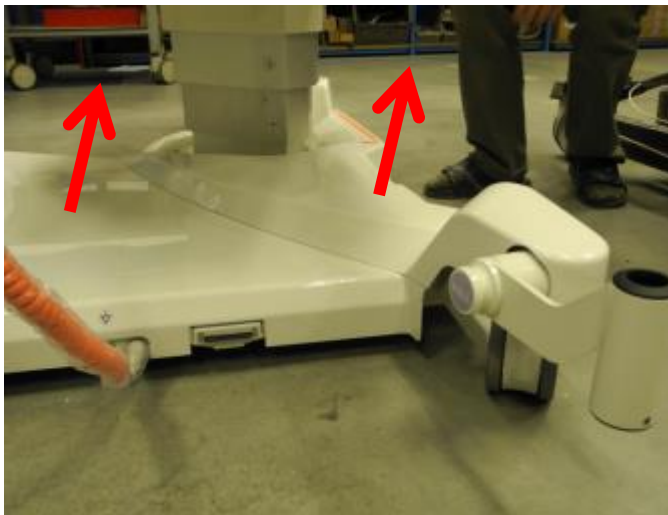

The cover is removed by screwing out three wrenches.

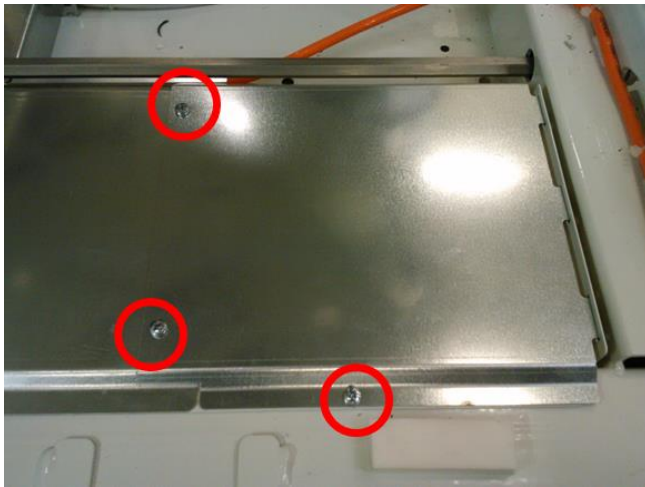

Insert the connector in the back-up battery.

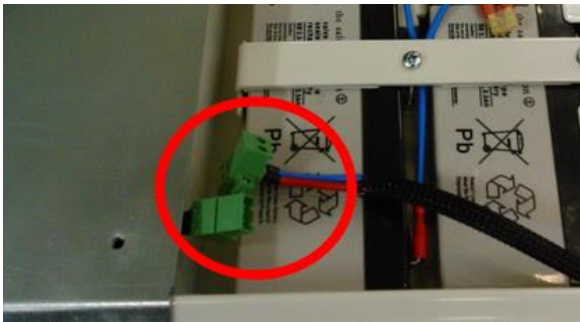

Put the protective cover in place and screw the Allen wrenches back on. Put the undercarriage cover back in place.

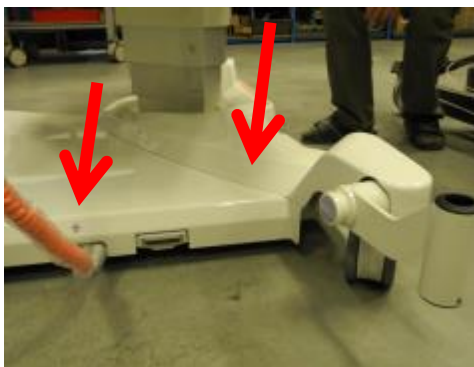

2 Overview of basic parts



1. back section
2. seat section
3. foot section
4. castor, directional 1x
5. castor with brake 3x
6. plastic covers of chassis
7. leg rests with leg straps
8. headrest
9. back handle for transportation
10. eurolath along seat section (accessories)
11. tray on swinging holder (accessories)
12. side control panel
13. control light for power supply
14. holder for infusion stand
15. hand grips
16. side rails with electric control panel
17. central brake
18. manual CPR functions
19. leg rest tray
20. detachable bed-head (accessories)

2.1 Overview of basic versions

PPB-AX	basic type
--------	------------

2.2 Overview of standard colour versions

Substituted by the letter "X".

A – Purple	M – Yellow
B – Blue	P - Orange
F – Green	

2.3 Safety

Standards and specifications

Referenced standards are listed in the Declaration of Conformity.
The manufacturer has implemented certified quality management system in accordance with the following standards:

- ISO 9001
- ISO 14001
- ISO 13485

Fire Extinguishing Information



Warning:
Note

Danger of frostbite by contact of CO2 with human skin!
Do not use halotron extinguisher in closed rooms without ventilation – danger to your health!

The medical product is categorised as energised electric installation, hence, fire can be extinguished by the following types of extinguishers.

Use	Do not use
Powder extinguisher	Foam extinguisher
CO2 extinguisher	Water extinguisher
Halotron extinguisher	

3 Function



Warning: Caution

The essential functions are lying, sitting and supporting the woman in labour. Additionally, it is the CPR position.

Delivery bed is used by mothers before and during delivery and after delivery. A bed equipped with adequate accessories offers birth mothers the opportunity to achieve their optimum position for birth. Positioning and handling the bed is not an obstacle in providing healthcare. Handling the foot section, especially by folding it (fast way to store it under the seat/back section) at the end of the second stage of delivery creates enough space to perform obstetrical and vaginal surgeries. It is also useful for practical training of medical students and midwives. It also enables positioning on the side until the foetus is removed (supine syndrome prevention), as well as the use of other medical devices (resulting in ME system) for continuous control of reduced venous return, blood pressure, routine ECG monitoring, pulse oximeter, NIBP, and capnometry. During procedures it is possible to use approved surgical devices (HF) for making incisions or coagulation. If it is necessary to perform cardiopulmonary resuscitation, it can be performed in this delivery bed including the use of the defibrillator. Delivery bed is also equipped with a Trendelenburg position. After the delivery and the transfer of a birth mother it is necessary to wash and disinfect all the easily removable parts and light upholstery together with plastic parts and covers again.

3.1 Interaction

When using the delivery bed as part of the medical system, certain elements (medical devices) may interact. Before this application it is necessary to follow recommendations provided in the user manual of the delivery bed AVE2.

3.2 General instructions

The birthing bed may only be operated where the conditions of valid standards for el. distribution in medical facilities are met. According to the Act on Means of Medical Instrumentation the product may only be operated by persons with adequate qualification.

3.3 Application environment 5

Outpatient (ambulatory) care, which is provided in a hospital or other medical facility, under medical supervision and me equipment, is provided for the need of persons with illness, injury or disability for treatment, diagnosis or monitoring.

4 Intended use

Birthing bed is designed to be used by mothers-to-be for vaginal delivery. The birthing bed is designed to enable different birthing positions in all delivery birthing stages including postpartum period.

4.1 User population

- Pregnant women during ambulant and stationary pregnancy check-ups and/or in all labor stages and her companions.
- Caregivers and hospital staff (midwives, labor and delivery nurses, doctors, and technical personnel, transport personnel, cleaning personnel, interns and birth professional students)
- Maintenance personnel

4.2 Contraindications

Contraindication is the use of the birthing bed for elective (planned) Caesarean sections. The birthing bed cannot be used to leave the newborn on unattended.

The birthing bed cannot be used as a crib for the newborn.

The birthing bed is not intended for use as a general hospital bed.

4.3 Operator

- Caregiver
- Patient (based on individual patient status assessment by caregiver the patient can utilize dedicated device functions)

5 General safety



Warning: Caution

Birthing Bed is not primarily intended for newborns. For this case there is a special cot which comes as a separate medical device. It is assumed that the position of the baby during breast-feeding is under the constant control of the mother and thus any uncontrollable movement of a newborn on the bed is improbable. After breastfeeding the newborn baby is moved into the cot intended for this purpose. The caregivers are informed about potential risks in the instruction manual.

Do not operate the bed in rooms with inflammable gases/vapours. Danger of injury/damage of the equipment.

Use only ventilation or nasal-type oxygen supply units. Do not use the bed in oxygen tents (risk of injury or damage of the equipment).

Any serious incident that has occurred in relation to the device should be reported to the manufacturer and the competent authority of the Member State in which the user and/or patient is established!

Only authorised and trained person using the tool is allowed to change fuses and power supplies!

This medical device is not intended for oxygen enriched environment!

This medical device is not intended for use with flammable substances!

This medical device is not portable medical electrical equipment!

Make sure the duty cycle (2 min ON/18 min OFF) is not exceeded during bed positioning!

Patient is allowed to use selected control elements only if hospital personnel had assessed that the patient's physical and psychological state is in accordance with use of them and only if the hospital personnel had trained the patient in accordance with the instructions for use!

- **Leave the bed in the low position when the patient is unattended. This can reduce the possibility of patient falls and the severity of any resultant injuries.**
- Make sure to fix and set the accessories properly (tightening of handles etc.)
- Do not dismantle or execute unqualified repairs of motors, control unit, etc.
- The birthing bedAVE2 must not be used in medical facilities with fire or explosion risks caused by air or in combination with nitrous oxide and anesthetics or cleaning agents.
- Construction modifications reserved!
- The bed must be equipotentially connected with other medical devices to prevent fire in combination with flammable substances and anesthetics during minor surgical procedures using high-frequency (HF) instruments.
- Never use other than original accessories. All original accessories are marked with an original label containing the name and brand of the manufacturer, designation of the

product and a code including further information (serial number or batch ID and date of manufacture).

- **Modifications to the birthing bed are forbidden.**
- **The birthing bed is intended only for use by medical professionals and for woman in labor (locked siderails and headboard as handles or functions buttons on inner side of siderails for her higher comfort).**
- **Bed maintenance cannot be performed while ME equipment is in use!**

5.1 Electromagnetic compatibility

Bed is intended for hospitals except for near active HF surgical equipment and the RF shielded room of a medical system for magnetic resonance imaging, where the intensity of EM disturbances is high.

Bed has defined no essential performance.

⚠ WARNING!

It is recommended to avoid the use of this device next to or in block with other device, because it could lead to improper operation. If such use is needed, this device and the other equipment should be under surveillance to verify proper operation.

List of used cables:

1. **Mains cable**, maximum length 6 m

⚠ WARNING!

Use of the accessories, converters and other cables, than specified and provided by manufacturer of this bed could lead to increase of electromagnetic emission or lower the electromagnetic immunity of this bed and lead to improper operation.

⚠ WARNING!

Mobile RF communication device (including end use devices like antenna cables and external antenna) should not be used closer than 30 cm (12 inches) from any part of this bed AVE2, including cables specified by manufacturer. Otherwise this could lead to deterioration of functionality of this bed.

⚠ WARNING!

Do not overload the bed (SWL), respect the duty cycle (INT.) Maintenance in order to maintain the basic safety with regard to electromagnetic disturbances for the expected service life.

Manufacturer instructions – electromagnetic emissions

Emission test	Compliance
RF emissions CISPR 11	Group 1
RF emissions CISPR 11	Class B
Harmonic emissions IEC 61000-3-2	Class A
Voltage fluctuations / flicker emissions IEC 61000-3-3	Complies

Manufacturer instructions – electromagnetic susceptibility

Immunity Tests	Compliance level
Electrostatic discharge (ESD) IEC 61000-4-2	± 8 kV for contact discharge ± 15 kV for contact discharge
Radiated RF IEC 61000-4-3	3 V/m 80 MHz – 2,7 GHz 80 % AM at 1 kHz
Proximity fields from RF wireless communications equipment IEC 61000-4-3	See Table 1
Fast electrical transients / burst IEC 61000-4-4	±2 kV for power line repetition frequency 100 kHz
Surge IEC 61000-4-5	± 1 kV Line-to-line ± 2 kV Line-to-ground
Conducted RF IEC 61000-4-6	3 V (0,15 MHz – 80 MHz) 6 V in ISM bands between 0,15 MHz and 80 MHz 80 % AM at 1 kHz
Power frequency (50/60 Hz) magnetic field IEC 61000-4-8	30 A/m
Voltage dips, short interruptions on power supply input lines IEC 61000-4-11	0 % U_T ; 0,5 cycle At 0°, 45°, 90°, 135°, 180°, 225°, 270° a 315° 0 % U_T ; 1 cycle and 70 % U_T ; 25/30 cycle Single phase: at 0° 0 % U_T ; 250/300 cycle

Table 1 – IMMUNITY to RF wireless communications equipment

Test frequency (MHz)	Band (MHz)	Service	Modulation	Immunity test level V/m
385	380 - 390	TETRA 400	Pulse modulation 18 Hz	27
450	430 - 470	GMRS 460, FRS 460	FM \pm 5 kHz deviation 1 kHz sine	28
710 745 780	704 - 787	LTE band 13, 17	Pulse modulation 217 Hz	9
810 870 930	800 - 960	GSM 800/900, TETRA 800, iDEN 820, CDMA 850, LTE band 5	Pulse modulation 18 Hz	28
1 720 1 845 1 970	1 700 - 1 990	GSM 1800; CDMA 1900; GSM 1900; DECT; LTE band 1, 3, 4, 25; UMTS	Pulse modulation 217 Hz	28
2 450	2 400 - 2 570	Bluetooth, WLAN, 802.11 b/g/n, RFID 2450, LTE band 7	Pulse modulation 217 Hz	28
5 240 5 500 5 785	5 100 - 5 800	WLAN 802.11 a/n	Pulse modulation 217 Hz	9

NOTE There are applied no deviations to requirements of IEC 60601-1-2 ed. 4

NOTE There are no known other measures for keeping the basic safety based on EMC phenomena.

5.2 Mechanical safety



Warning: Caution

No objects that may collide with the bed (furniture, stands etc.) may be located near it (20 cm minimum). Special caution must be taken when operating moving parts of the bed. Damage of the bed or patient injury may occur as result of the bed parts colliding with other objects!

Before the mother in labor accesses the bed, the castor brakes must be engaged. Accessing the bed only from side of seat section.



The bed is not designed for mothers over 240 kg (527 lb.).

- No objects that may collide with the bed (furniture, stands etc.) may be located near it.
- Never enter the space under motor operated parts of bed (back, seat and leg rests).
- Before undertaking any resetting of the birthing bed check if no one is within reach of the moving parts.
- Before any resetting, check for kinked and/or tangled power cables.
- After setting the bed in place, all brakes must be engaged so as to prevent unwanted movement of the bed, e.g. during patient's occupancy. When setting the bed all four castors have to be in contact with the floor and the brakes engaged.

6 Setting the product

- Check all delivered items after unpacking.
- Install the equipment and accessories.
- Install front panel (in case of beds with dismantable front panels).
- Always install the bed on even floors.
- When installing the bed, avoid collision with power supply cable or excessive tensioning of the cable.
- Check correct plugging in.
- Avoid loose extension cables/ power socket bars lying on the floor.
- Check all mechanical and electric protection elements are in place.
- The bed has not any central switch. When disconnecting from power mains, plug off power cable.
- The power cable should always be accessible.
- The power cable must not be connected through an extension cord and it must not be connected to common multisocket inlets (three-way hub etc.).
- No input cable of other devices can lead over the surfaces of the bed or over the patient. When moving the bed, avoid pinching/kinking of any objects.
- Pay attention to proper fixing of the approved accessories listed in the manual.
- The birthing bed is installed by trained person. It can be operated in ordinary way by trained personnel only. Trained personnel must be also educated on appropriate height of infusion stand setting.
- The training is provided by BORCAD Medical a.s. (manufacturer) representative or its authorized dealership.

We recommend to set up the bed in to Welcome position:

- Straight "horizontal" position at the lowest possible height of the bed.
- The foot section and legrests is extended and set in the highest position, where it serves as a lying area.
- The bed is covered with government-issue sheets / disposable drapes.
- Side handles are in the active position; safety function.
- The hand grips are hidden away so they do not get in the way when the mother enters the bed.
- When the room is made dim in order to create a more pleasing atmosphere, the backlight of the bed is switched on.
- The wheels are braked with a central brake.
- The staff always briefly instruct the mother on how to use the bed (control the basic functions, the bed's adjustment) and showing the warning labels.

6.1 Transport, braking

The birthing bed also allows for the transport of a patient. This is, however, subject to the following conditions:



Warning: Caution

The birthing bed allows for the transport of a patient by pushing forward using the handle on the back section. Before transporting the patient, disconnect and store the power supply cables and equipotential and other connections properly, to prevent their tearing off. Use the handle on the back section only to transport the bed. Do not transport the patient if the bed is set in the chair position. If you do so, you can cause injury to persons or damage to the device. Before transporting the patient, the central brake must be released.

Before running the device ensure that the front wheels are set in the direction of travel, meaning that the front wheels are not pushed by the bed. In this situation the wheels can be damaged.

When transporting the patient, the locking pedal must be used to secure the front directional castor in a straight direction. Otherwise the patient has to be transported by two persons.

When transporting the bed within hospital premises, make sure that the patient as well as all equipment, such as cables (including the power supply cable), hoses, tubes, etc., are safely placed in the area bounded by the circumference of the bed. Otherwise you can cause injury to persons or damage to the device.

During transport, check the stability of the infusion stand - it can hit doors or ceiling lights. Before transporting the patient, set the stands to the lowest position. Otherwise you can cause injury to persons or damage to the device.

After the transport, reconnect the power supply cable and secure the bed with the central brake. Otherwise you can cause injury to persons or damage to the device.

Do not expose the bed to prolonged extreme effects of external environment (snow, frost, rain, etc.). It could damage the device.

Transport the bed in its lowest position and make sure that it is not transported over areas with lateral inclination exceeding 5°. In case of interrupting the transport (stopping the movement of the bed), always secure the bed with the central brake. Otherwise you can cause injury to persons or damage to the device.

The maximum threshold crossing height is 20 mm.

During transport, pay attention to the leg rests, side rails, foot section and hand grips to prevent hitting doors and other objects. Otherwise you can cause injury to persons or damage to the device.

When transporting the birthing bed (with/without the patient), the following instructions must be observed:

- 1) Move the rest area of the bed to horizontal position, the handles being in active (upper) position.
- 2) Move leg supports to horizontal position, thus constituting compact rest area together with the mattress and avoiding leg support projection outside of the circumference of the bed.
- 3) Disconnect power cable, equipotential and other connections, thus avoiding their pulling out.
- 4) Use the handrail on the back section for transport of the bed.
- 5) When transporting the bed by one operator, activate the direction castor, otherwise, the transport must be carried out by two operators.
- 6) During transport interruption, central brake must always be applied.
- 7) After the transport, connect the power cable and secure the bed with the central brake.



Warning:
Caution

When crossing transversal obstacles, lower the rest area to the lowest position.
Do not transport the bed at places with side slope exceeding 5°.
When crossing a threshold, its height must not exceed 20 mm.
Observe the following security hints when transporting the bed:

- Avoid crossing of cables.
- During transport, the power cable must be fixed with the hook.
- Be sure the castors are unlocked before transport (see section related to adjustment of the castors and transport of the bed).

Move the bed only on the floors with suitable surface.

6.2. Transport



Warning:
Dangerous electric voltage

Before transport, disconnect power supply cables, equipotential and other connection lines, thus avoiding their pulling out.

The power cable must be fixed to the bed at the selected point using plastic hook! Never wind up the cable on the bed/its parts, e.g. side handles, front section, handrails and other items!



In case of visible damage of the power cable, do not use the birthing bed and/or the cable! Always call technical service operator!

Only rear handles can be used for transporting the bed!

Do not transport any patient, when the bed is in "chair" position. Danger of injury to the patient or damage of the equipment!

When transporting the bed within the building, be sure the patient and all items, e.g. cables (incl. power cable), hose, pipe etc. are properly positioned within the circumference of the unit. Danger of injury to the patient or damage of the equipment!

During transport, stability of the infusion stand must be monitored. Avoid hitting the doors/ceiling lights. Before transport of the patient, always put the infusion stand to the lowest position, thus avoiding injury to the patient or damage of the equipment.

Suitable floor:

- Floor tiles
- Hard linoleum
- Cast floor

Unsuitable floor:

- Too soft, not sealed or defective flooring
- Soft wood floor
- Soft and porous artificial stone floors
- Carpets with lining
- Soft linoleum
- When transporting the bed at a distance, check the castor control is active (main control lever).
- Release the brake before transporting the bed.

The delivery bed is fitted with four castors (150 mm on default) and it may be moved in all directions. Castor functions are controlled by two double-way pedal brakes.

Setting of the wheel pedal:

STOP	Three castors locked
NEUTRAL	All castors free, spinning around their axle
GO	The left front castor is locked in straight direction, the other castors are unlocked, turning around their axes.

Symbols meaning of arrest control pedals:

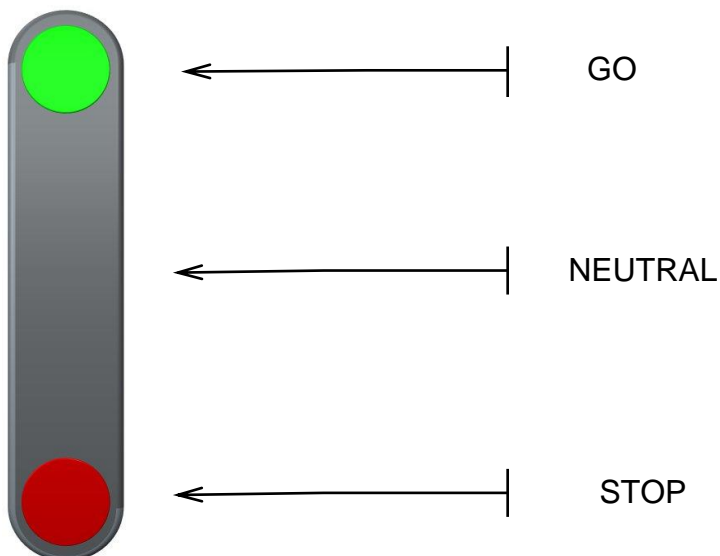

7 Operating the bed



Warning: Caution

The birthing bed is not designed for permanent operation – motors can only be loaded up to the values defined on the label, i.e. 2 minutes of operation followed by 18 minutes of stand by. Excess workload of the device may result in automatic stop. Under such conditions, authorized service action is needed.

The bed includes firmware that can be updated only by an authorised service technician. This firmware is protected against unauthorised access by mechanical housing (tool is needed to access), by seal (components with processor are sealed), by exclusive compatibility with an authorised software tool and by check of compatibility of the new firmware with the bed.

The bed includes firmware that can be updated only by an authorised service technician. This firmware is protected against unauthorised access by mechanical housing (tool is needed to access), by seal (components with processor are sealed), by exclusive compatibility with an authorised software tool and by check of compatibility of the new firmware with the bed.

- Components of the product are not treated against fire. Hence, avoid handling near open fire. If this rule is not observed, the device may catch fire.
- When handling the product, please pay attention to the protection of a power cable against mechanical damage, especially its insulation.
- In case of fuse replacement pay attention to correct selection of a fuse type. Fuses need not be replaced by an authorized BORCAD Medical a.s. service; it can be done by a qualified electrician.
- Pay attention to free passage of hoses, cannulae, and other free parts (in case infusions are used) so as not to get these pinched in the moving parts of the product (rails or leaning parts may be the risk locations).
- When positioning the product, collision with objects may occur. Keeping safe distance from other objects is recommended in order to prevent damage and injury.

7.1 Side rails

The woman sitting in the chair can use the handles for increasing her sitting stability or pressing internal functional buttons to increase her sitting comfort.

Side rails are also intended for medical professionals. During closer access to woman in labor siderials can be parked away from outer side.

7.1.1 Description of the control panel for the woman in childbirth

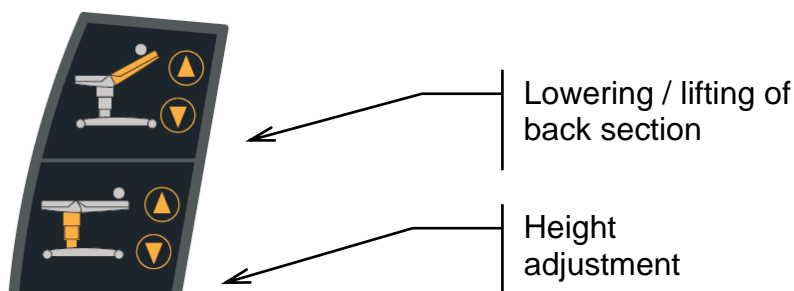

7.1.2 Adjustment of the handle in inactive position

To initiate lowering, push the trigger in the marked direction with one hand, then lower the rail to the lowest position possible. The parking position is suitable for birth mother to get easily on the bed, eventually for better access to the patient during birth.

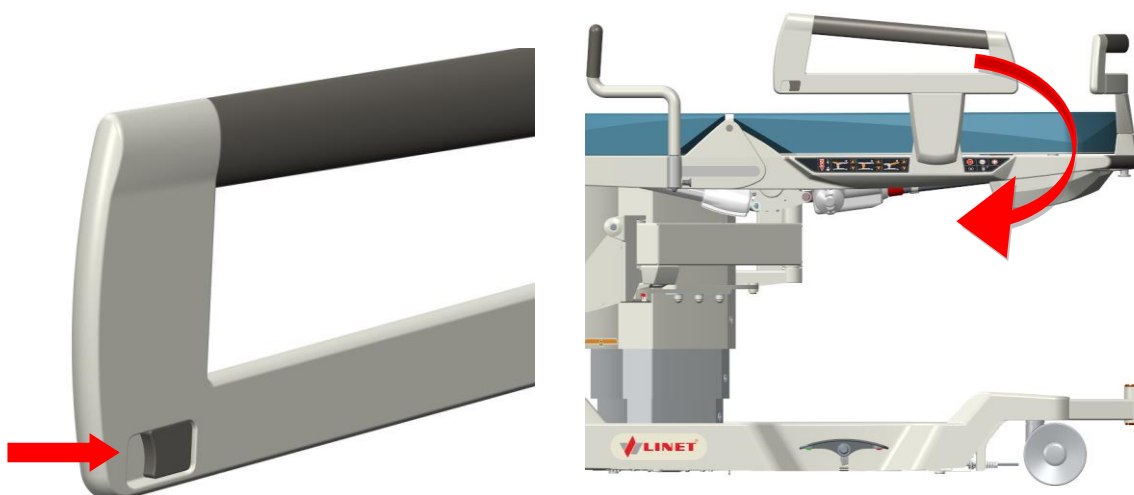

7.1.3 Adjustment of the handle in active position

In the active position, you only need to pull the handle to the highest position. The rail locks in the active position automatically.

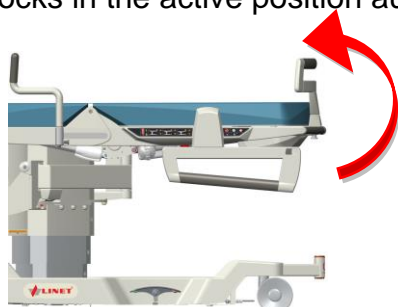

Warning: Caution

Always check functionality of the side rails before use.

Upon regular service check-up it is necessary to check and adjust side rails

Siderails are intended to be a reminder, not a patient restraining device.
The siderails should always be in a full upright position and latched when a patient is unattended.

7.2 Side control panel



Warning:
Caution

Side control panel is located on both sides of AVE2 birthing bed. The panel can be operated by trained personnel only.

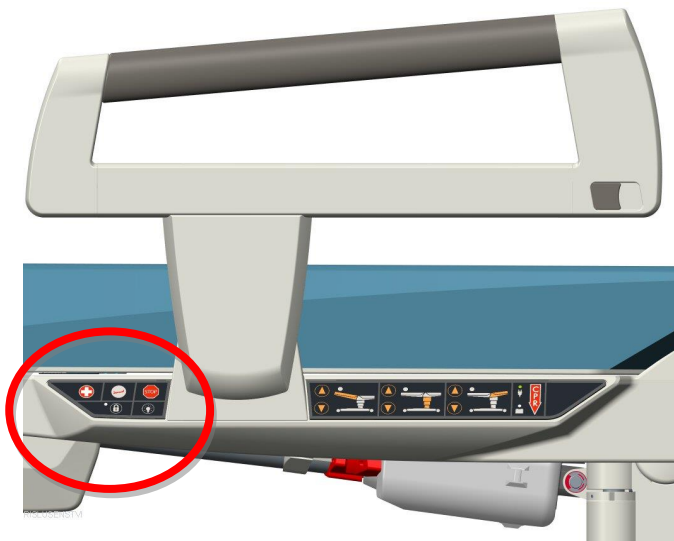

Call the nurse



Holding the button initiates setting the bed to anti-shock position

Stopping bed movement

Locking of the bed control. You activate the control lock with pressing the button (when the diode beams, it is activated). For deactivation hold the button for at least 3 seconds (it is deactivated when the diode does not beam).

Under carriage light on/off (options)

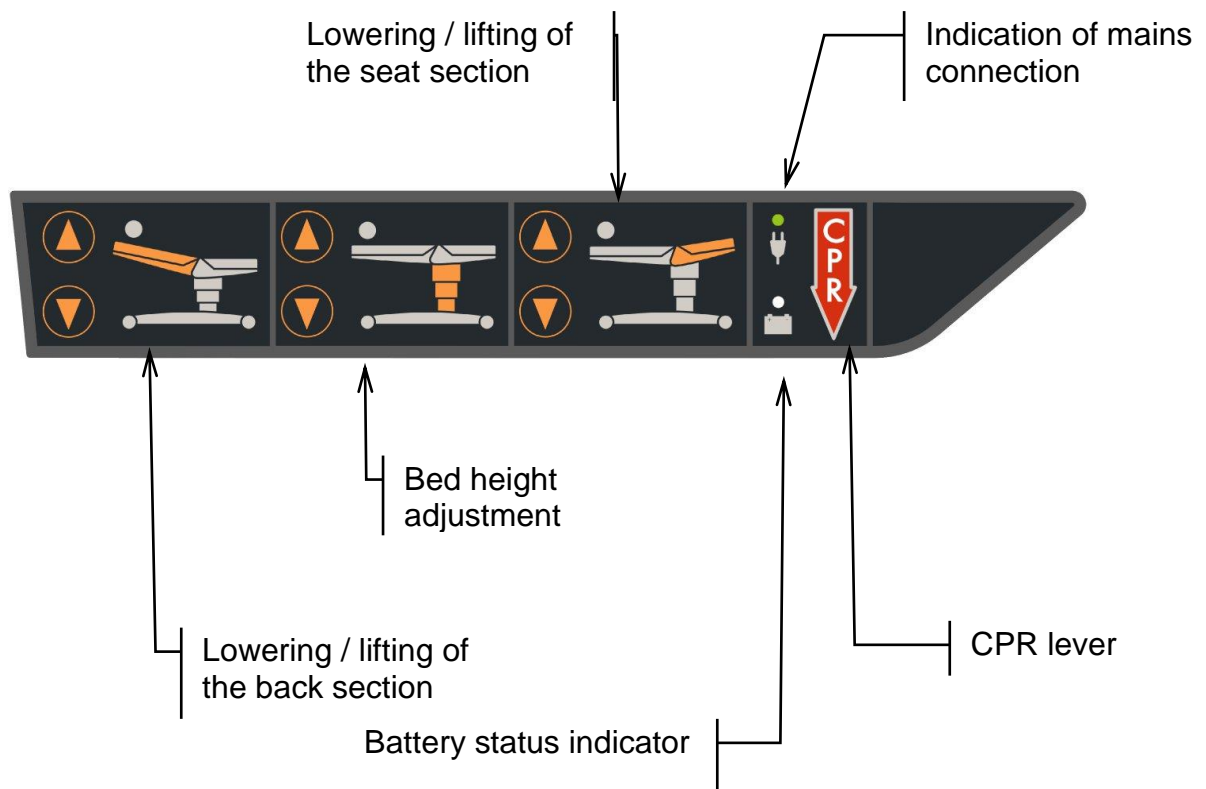
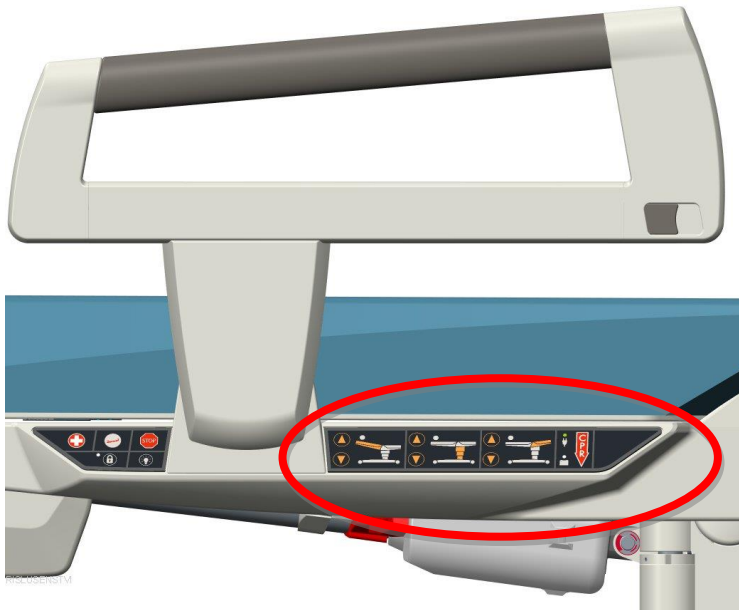

7.3 Manual setting of the CPR



Warning:
Caution

The CPR controller is marked with red information labels on both sides of the back section. The labels are marked with CPR text.

During movement, the back support must be loaded (e.g. with the patient's weight).



To manually position the back rest, pull the red CPR lever while pushing the back rest of the bed down. Keep holding the lever. The CPR lever is located on the back rest of the bed and it is accessible from either side.

The back rest of the bed sinks depending on the weight of the patient.

Note: Before first use of the bed, we recommend performing the movement of the back rest of the bed multiple times using the CPR function. The CPR function may be slightly impaired if the bed has not been used for some time.

Important: To start the CPR function, the patient must be on the birthing bed.

Important: The CPR function is in full agreement with the requirements of valid norms.

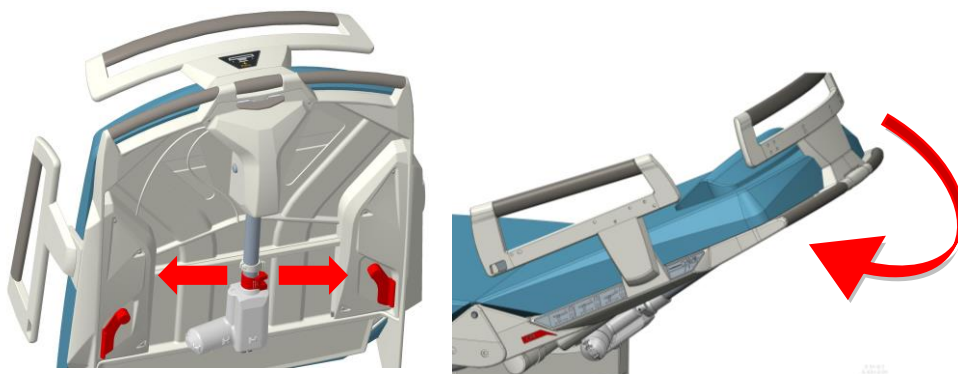

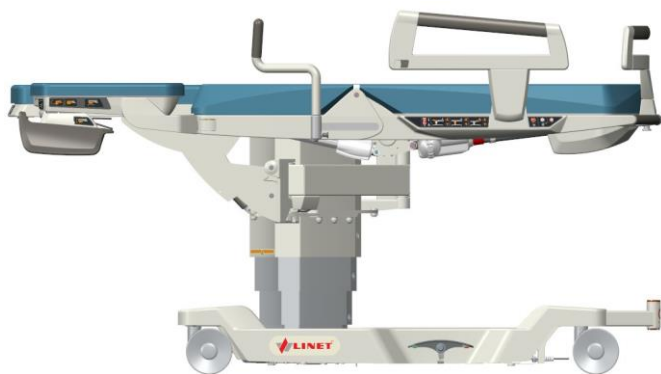

To reset the back section to its original position, use motoric positioning (activates via hand control, side control panel or side rail panel).

7.4 Electric setting of Trendelenburg



Warning:
Caution

The controller is marked with orange on both sides of the back section.

If the bed stops during the positioning movement and the control box generates a sound signal, the foot section has not been fixed properly.

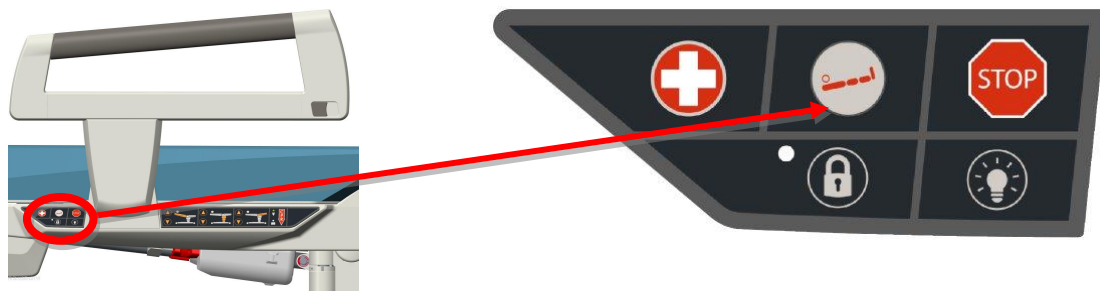

For positioning of the back section, push the above-marked button and hold it until the positioning comes to an end.

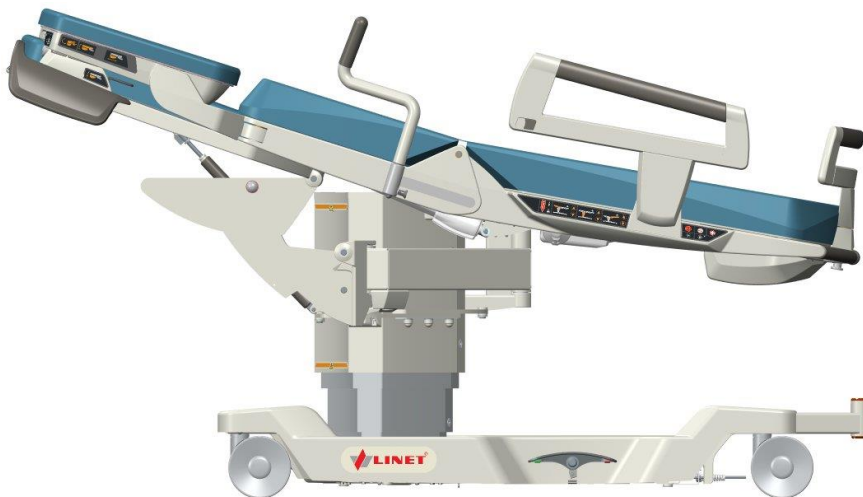

To reset the back section to its original position, use motoric positioning (activates via hand control, side control panel or side rail panel).

7.5 Setting of the foot section



Warning: Caution

The load capacity of foot section is 150 kg maximum (330 lb.).

The load capacity of foot section and leg rests together is 170 kg maximum (374 lb.).

Do not overload the footrest due to the unsecured position. It is necessary to always secure the part in the end positions (parking, active)!

Foot section positioning (sliding in/out, lifting/lowering, inclination) always without load.

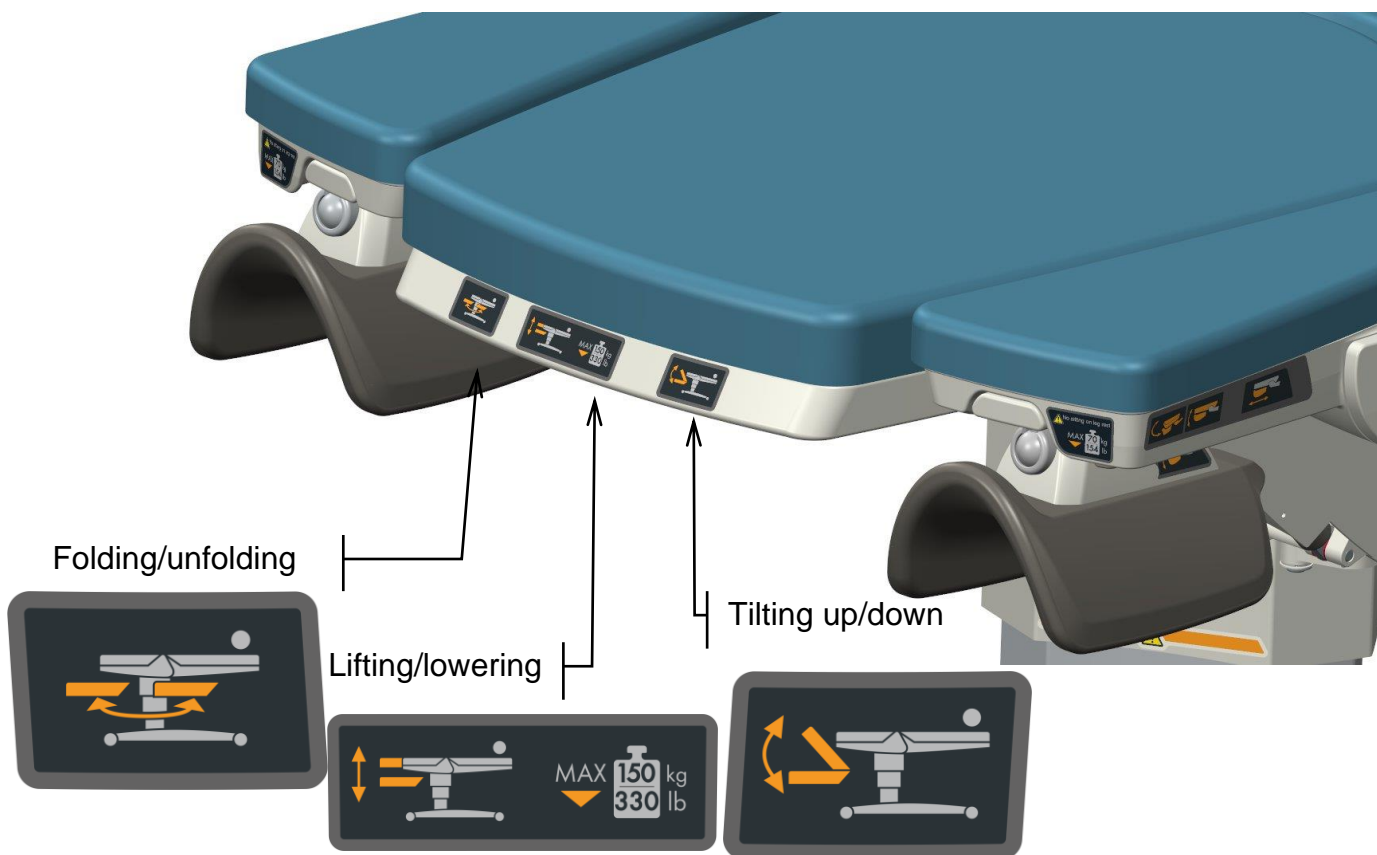

7.5.1 Folding/unfolding

In lowered position, the foot section can be folded and locked in two positions:

a) **Folded** (the part is hidden under the seat section)

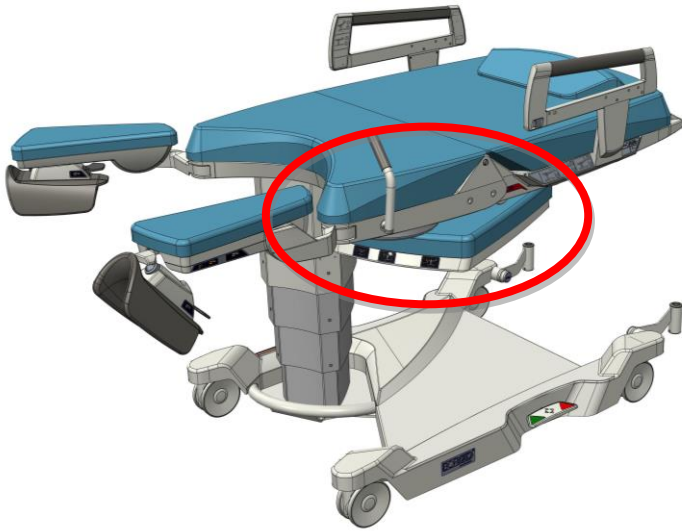

b) **Unfolded**

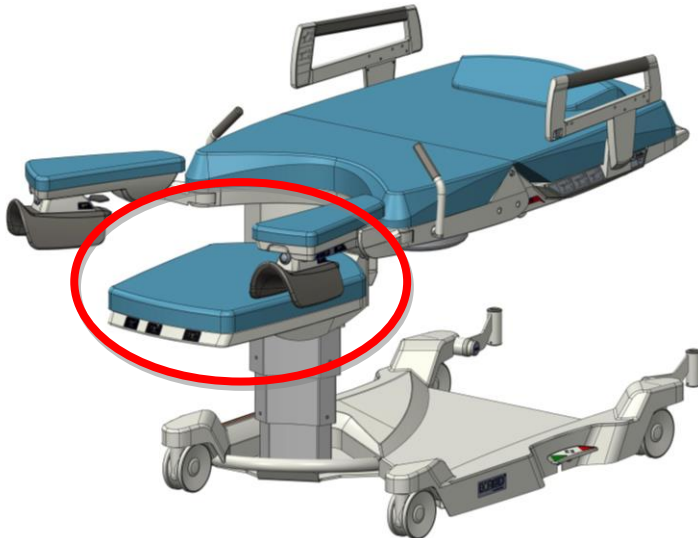

Adjustment to any of these positions can be done by pressing the controller in the direction of the marked arrow and turning the foot section towards/outwards the operator. Once reached, the foot section will automatically lock in both positions.



Warning:
Caution

Before folding, always make sure the foot section is in the lowest position and back section is not in Trendelenburg position!

In case of putting aside the upholstery of the foot section from the bed, it must be placed on its wide laying surface on flat surface such as ground or bed. In case of lying the foot section on the edge side, the upholstery may be damaged due to heavy weight of the part.

When unfolding the foot section, other person(s) must not interfere.

7.5.2 Lifting/lowering

The surface of the completely pulled out foot section may be lifted up to the level of the seat. All listed positions of the foot section do not limit motoric setting of the birthing bed. Before loading the foot section, its correct locking should be checked by short moves to the sides.

Lifting

Pull the control lever with the right hand. At the same time grab the front edge of the foot section and pull upwards to the desired position. Releasing the control lever locks the selected position.

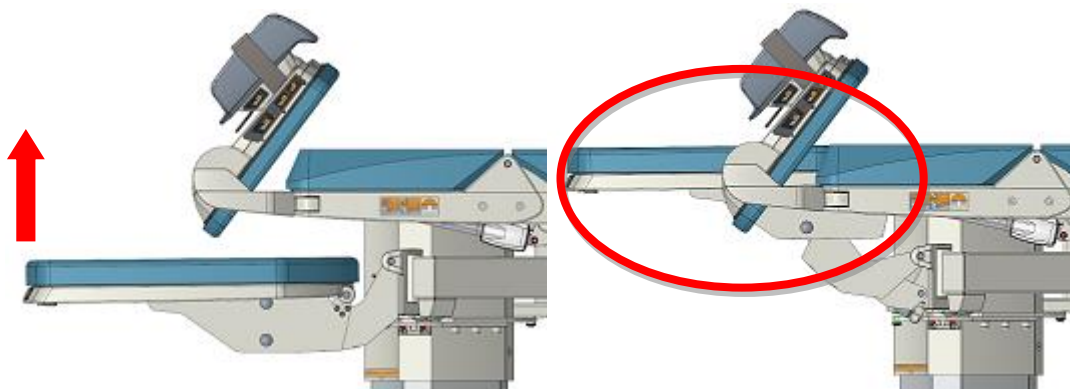

Lowering

Pull the control lever with the right hand and at the same time grab the front edge of the foot section and push downwards to the desired position. Releasing the control lever locks the selected position.

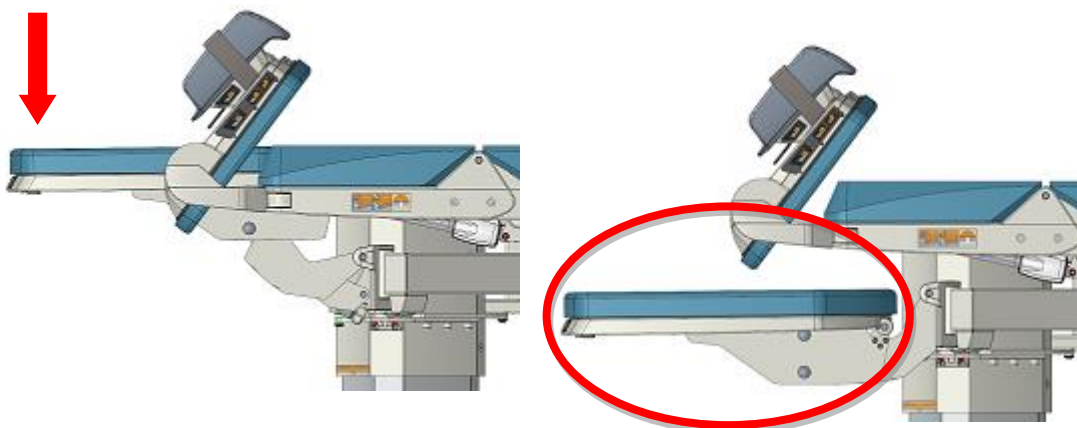

7.5.3 Tilting up/down

Pull the control lever with the right hand.



Then push the foot section downwards. You can lock the foot section in any position by releasing the control lever.

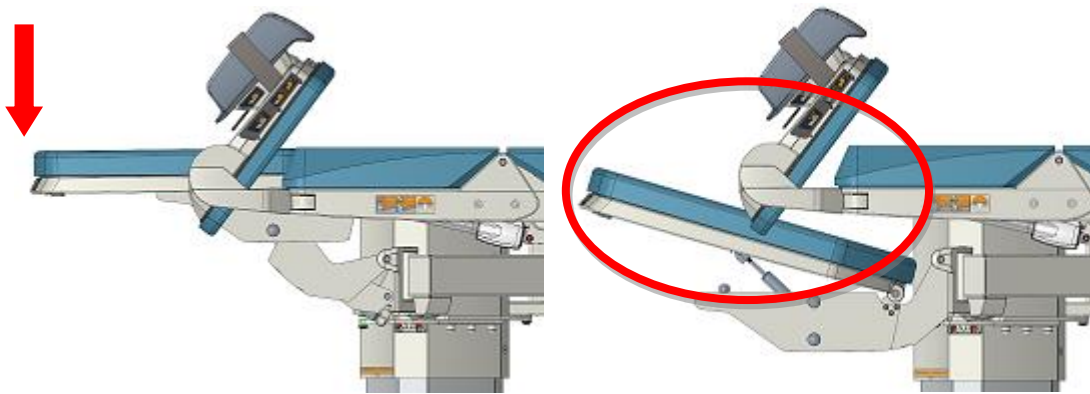

Uninterrupted push downwards results in low horizontal position of the foot section.

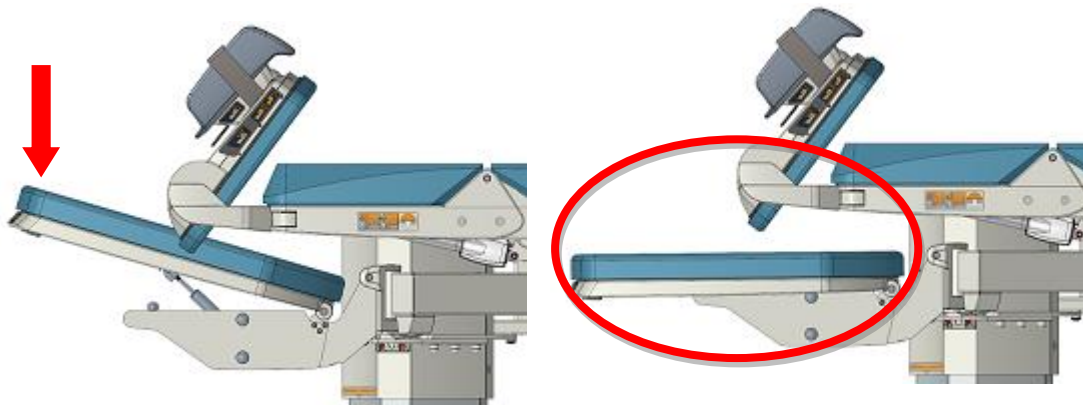

7.6 Adjusting the leg rests



Warning: Caution

The load capacity of one leg rest is 70 kg maximum (154 lb.).

The load capacity of foot section and leg rests together is 170 kg maximum (374 lb.).

Always brake the footrests plates before transport! This means to set up the lowest height level and turn them in a way that their edges do not overlap the edges of the footrests.

Manipulation with the foot section or seating section and with the leg rests can cause a collision, especially when the leg rests are situated close to the foot section or above it.

Motoric movement of the seat section requires proper visual control of the leg rests position. Therefore, be cautious when adjusting the particular positions.

Undetachable leg rests may be used as feet support (Foot rest position), in the Gynecologic position and in the Horizontal position to maximize the bed surface.

Basic overview

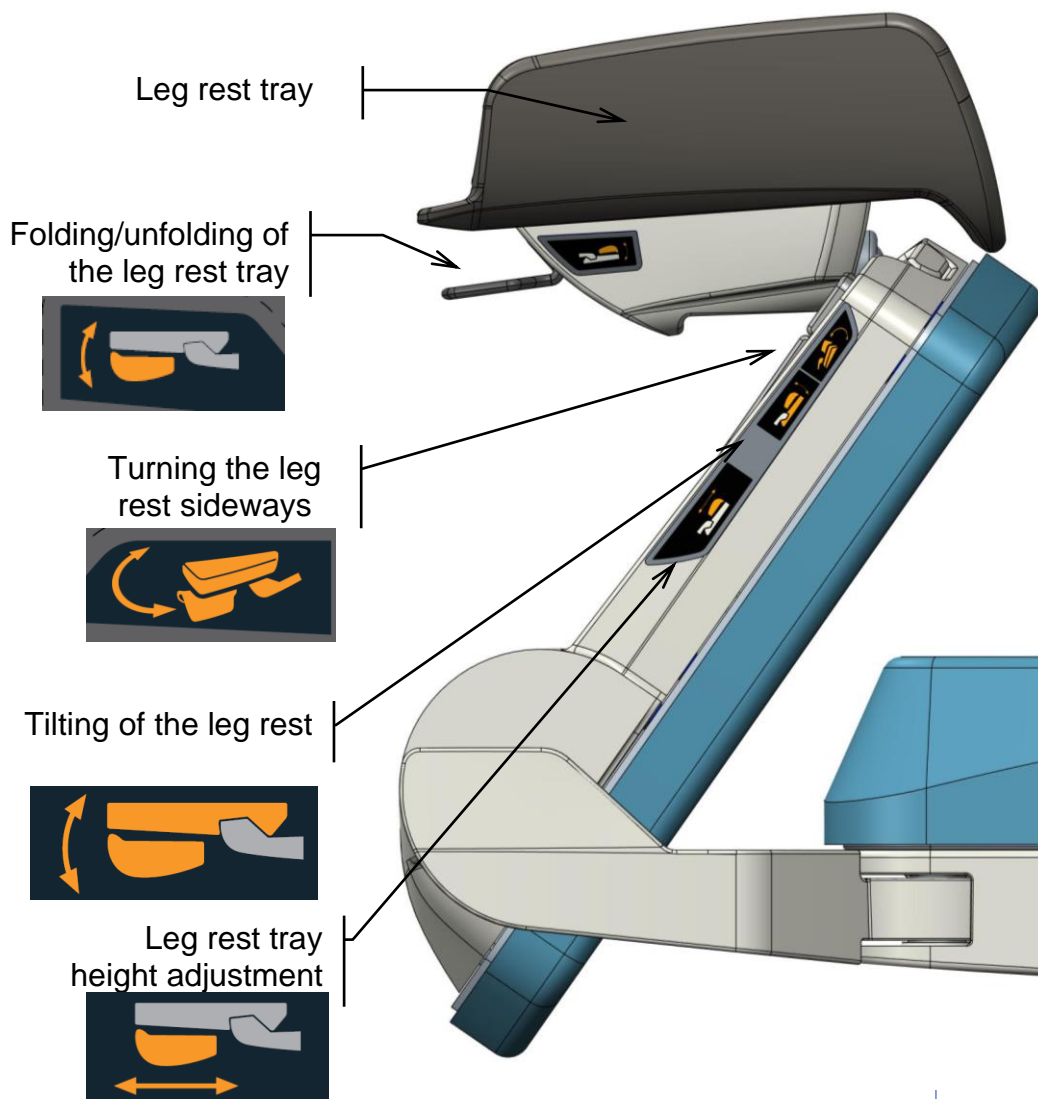

7.6.1 Gynaecological position

For positioning pull „Turning the leg rest sideways“ control lever as on the picture below

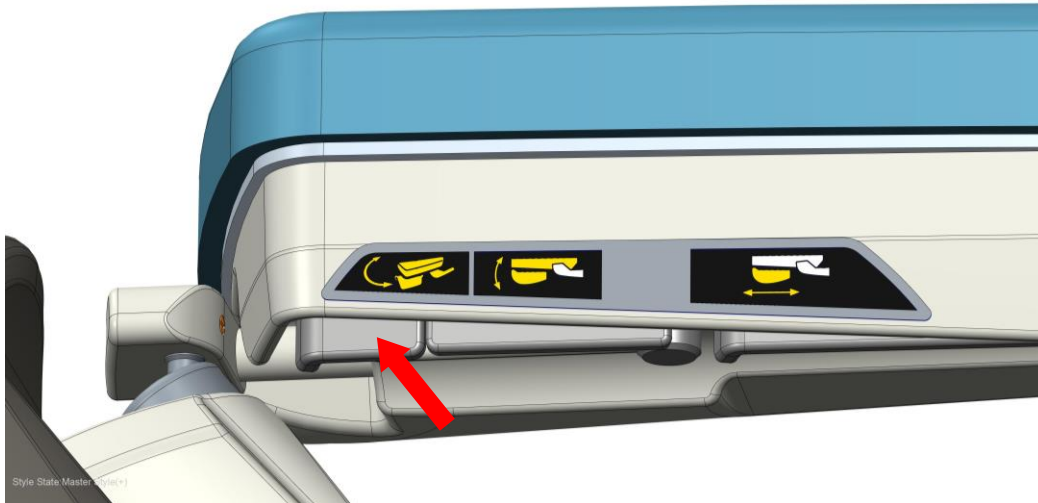

and with the same hand pull the leg rest in the desired position.

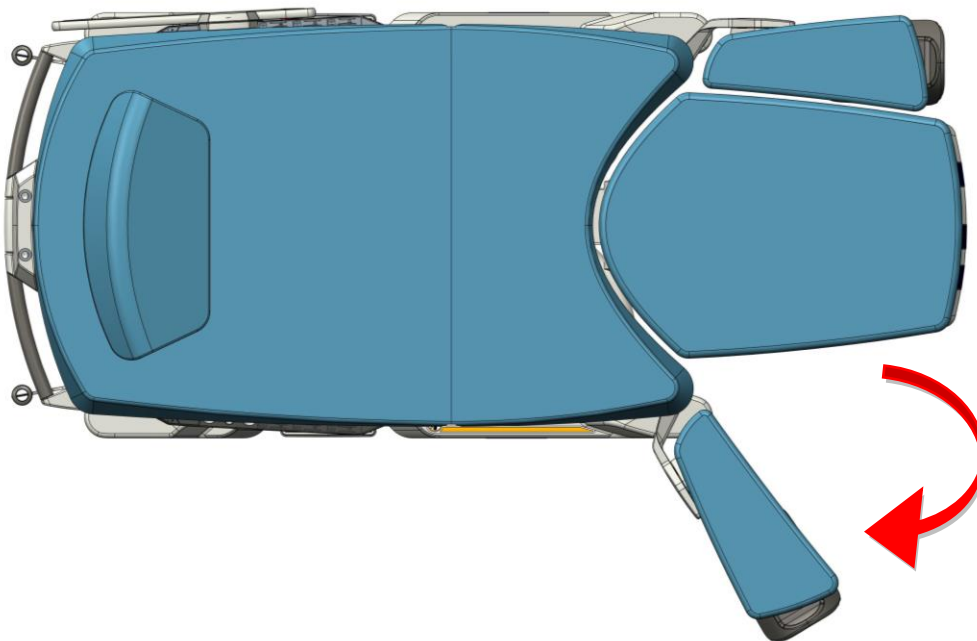

Then pull the „Tilting of the leg rest“ control lever as in the picture below

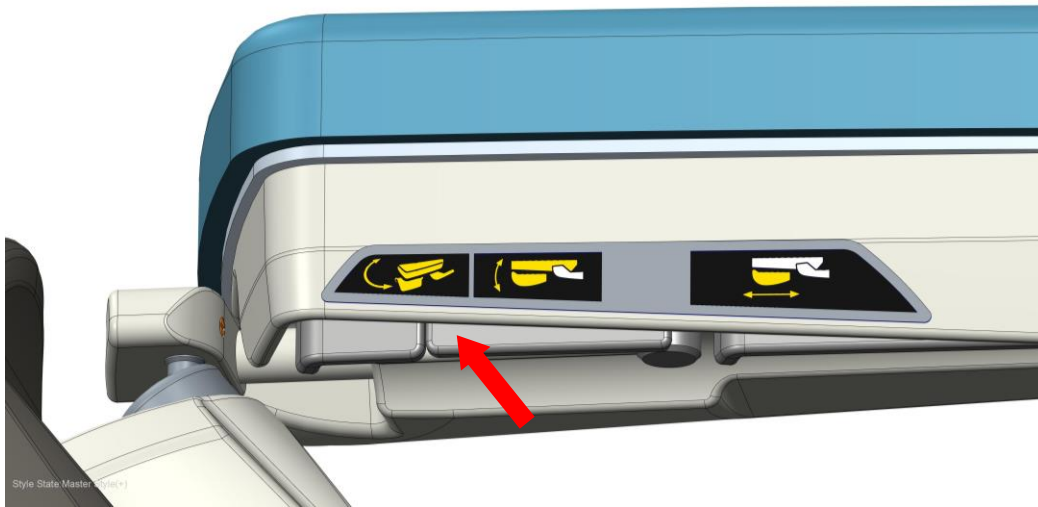

and with the same hand pull the leg rest in the desired position.

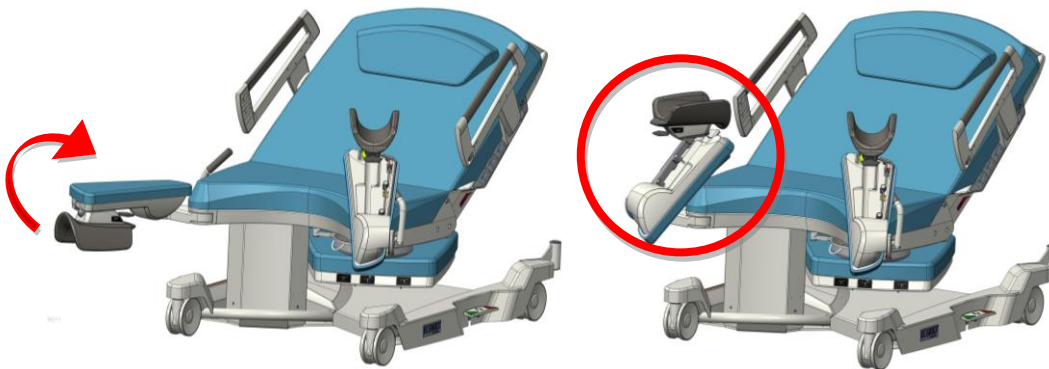

Then adjust the leg rest tray. With one hand pull the „Folding/unfolding of the leg rest tray“ control lever as on the picture below. Then with same hand pull the tray to the desired position. Releasing the control lever locks the tray in the position. To reset the tray to its original position, repeat the procedure reversely.

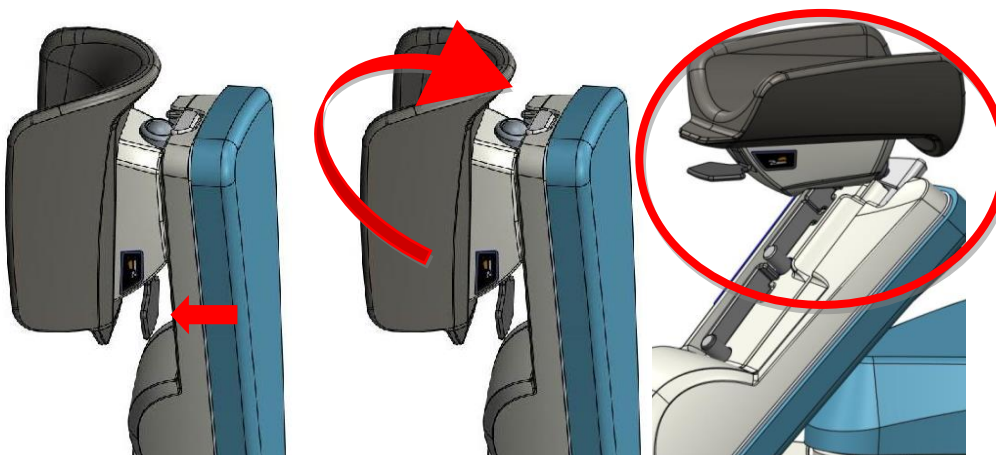

7.6.2 Foot rest position

The leg rests can be adjusted in the Foot rest position. For positioning pull „Turning the leg rest sideways“ control lever as on the picture below

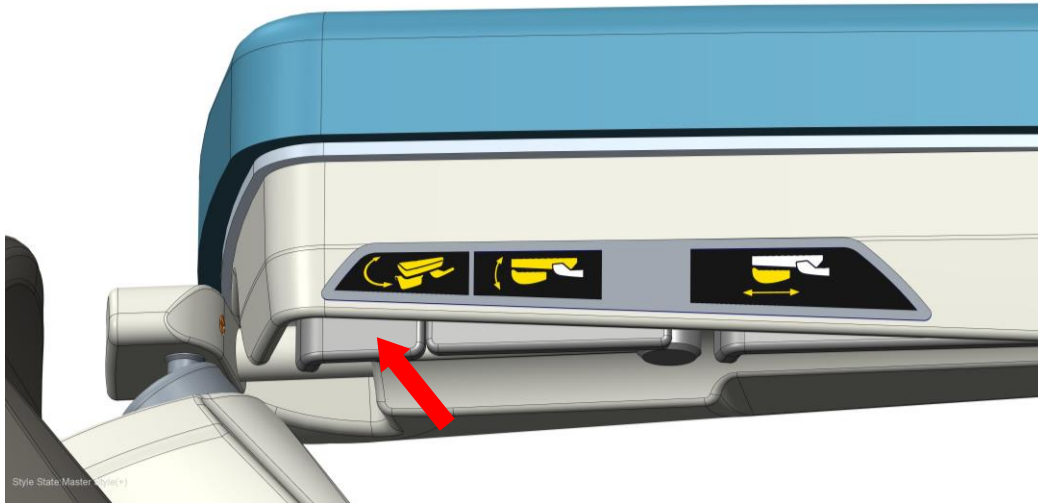

and with same hand pull the leg rest in the desired position.

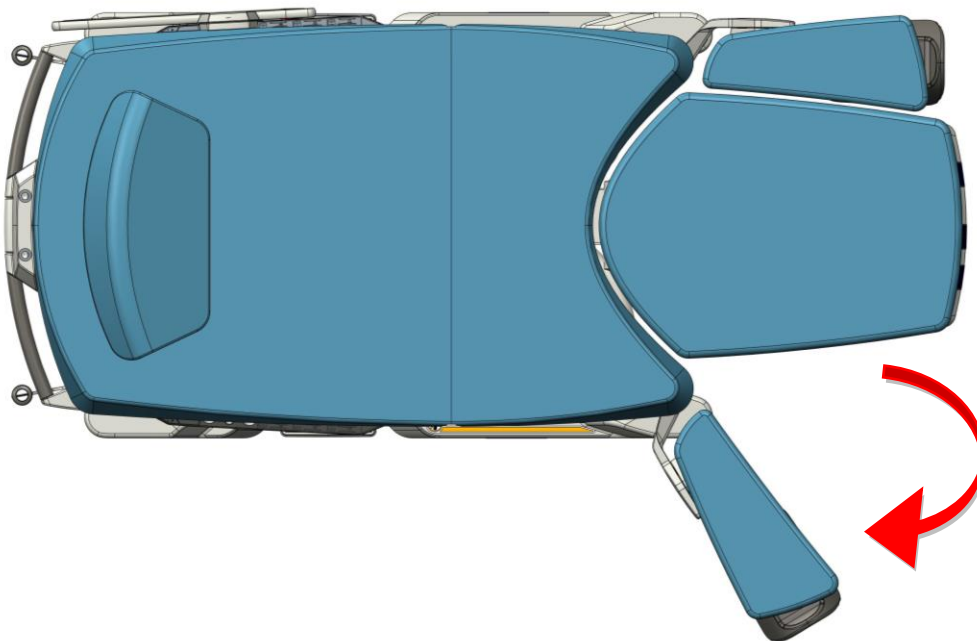

Then pull the „Tilting of the leg rest“ control lever as on the picture below

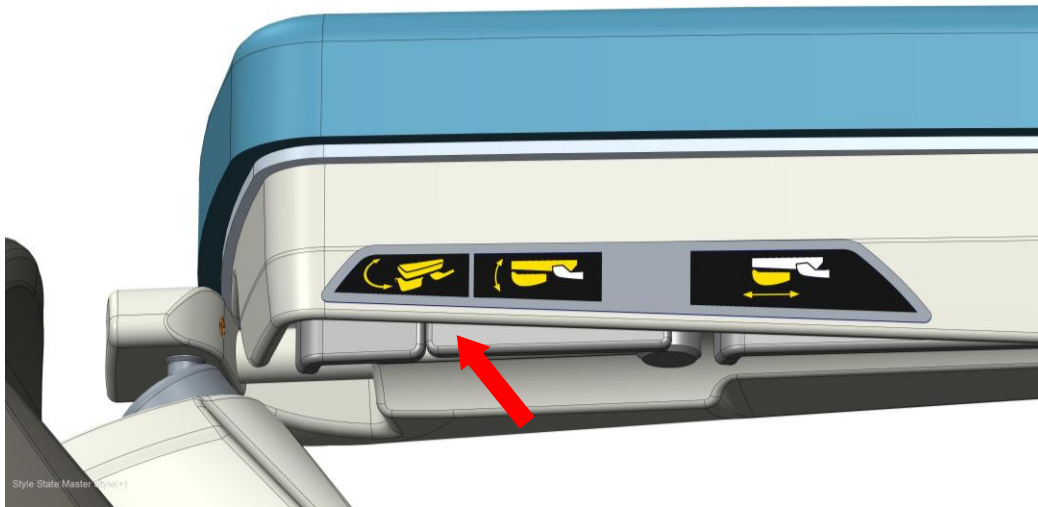

and with same hand pull the leg rest in the desired position.

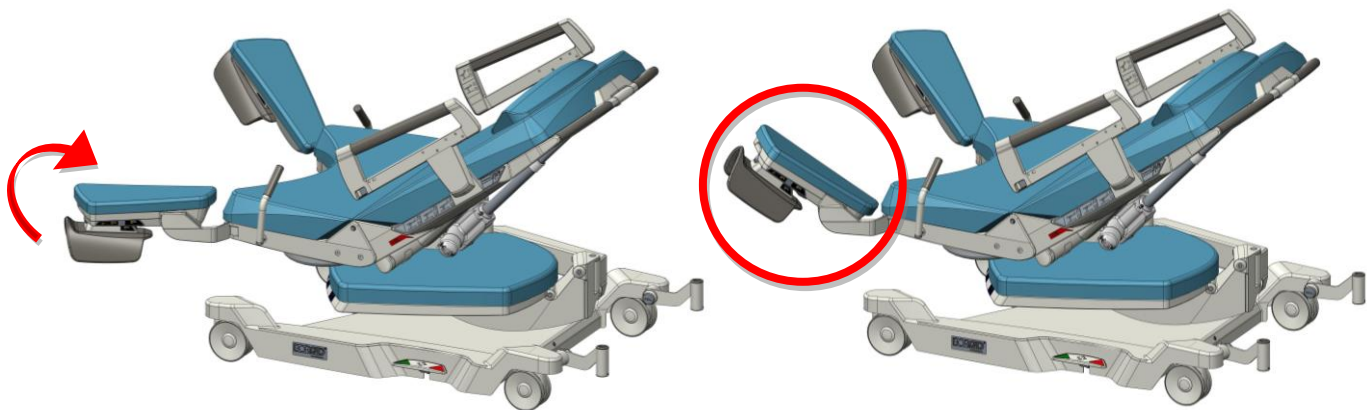

7.6.3 Maximum bed surface position

The leg rests can be positioned horizontally along the sides of the foot section. Due to this function, one laying surface can be achieved together with the seat and back sections. For positioning, pull „Turning the leg rest sideways“ control lever as on the picture below and with the same hand position the leg rest to straight direction, alike as the foot section.

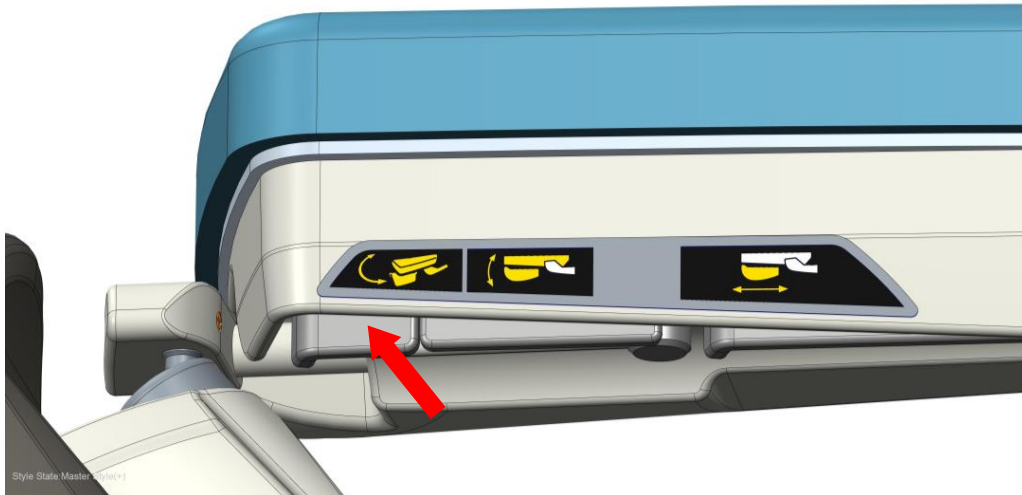

Then pull the „Tilting of the leg rest“ control lever as on the picture below and with the same hand position the leg rest in the horizontal position.

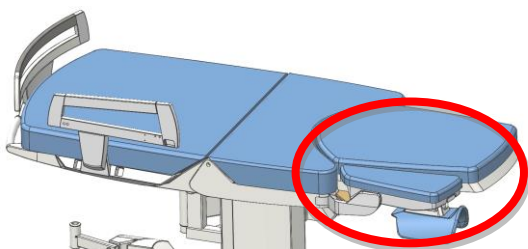
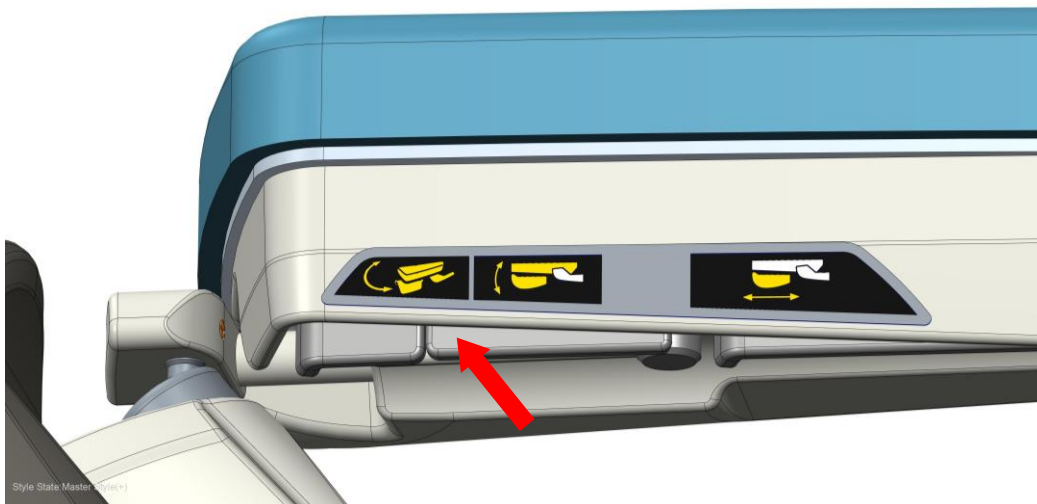

7.6.4 Turning the leg rests sideways

The leg rests can be turned sideways for better access to a birth mother. For turning the leg rest sideways, pull the control lever as on the picture below.

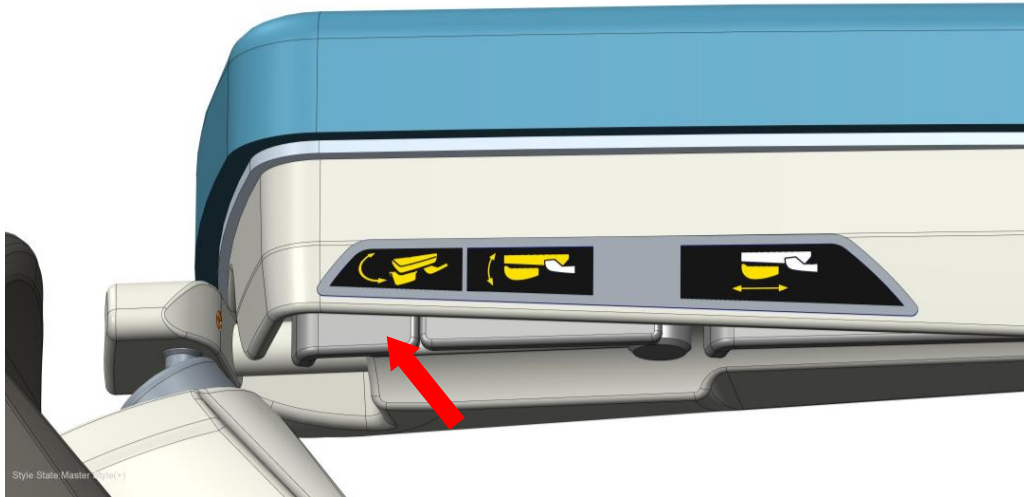

Then pull the leg rest to the desired position. Releasing the control lever locks the position. To reset the tray to its original position, repeat the procedure reversely.

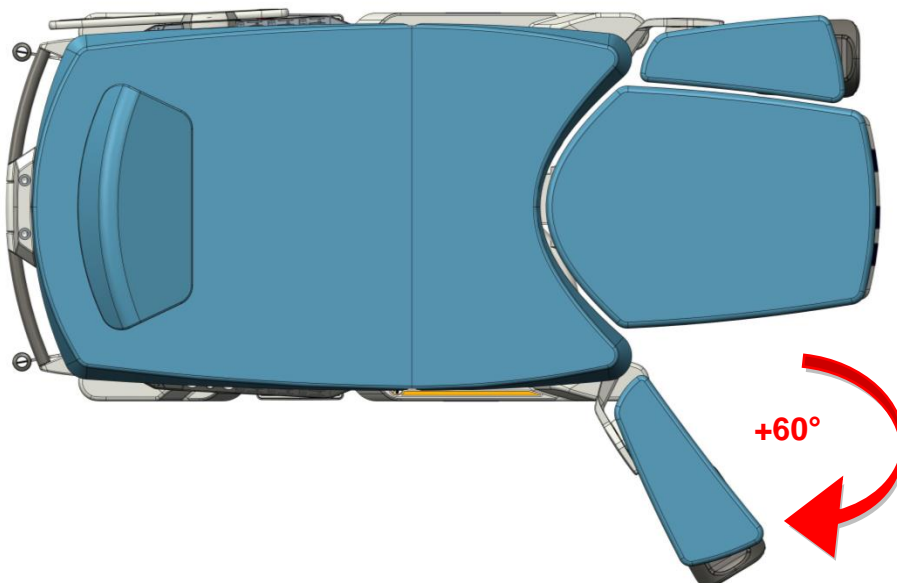

7.6.5 Leg rest tray adjustment

Leg rest tray can be individually turned sideways according to the physical proportions of the birth mother. To do so, the leg rest must be in "Gynaecological position". Then with one hand pull the control lever as on the picture below.

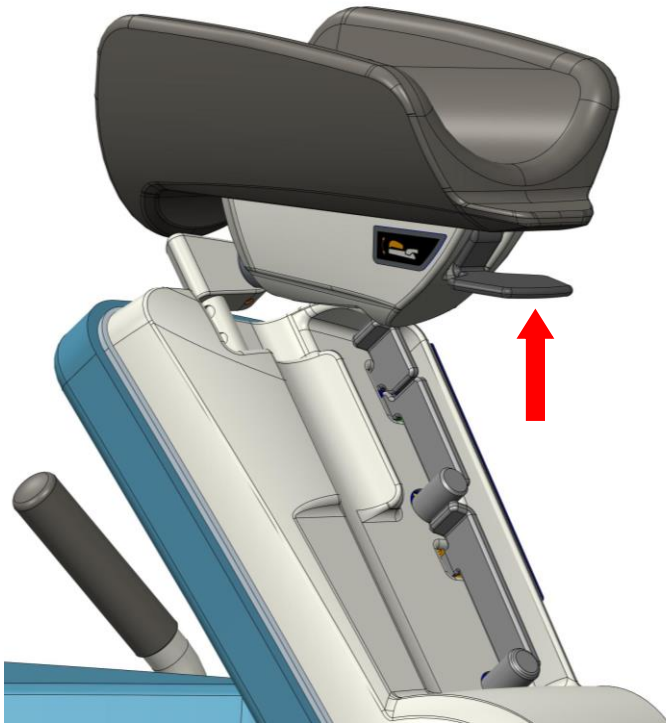

Then with the same hand adjust the leg rest tray in the desired position. Releasing the control lever locks the leg rest tray in the position. To reset the tray to its original position, repeat the procedure reversely.

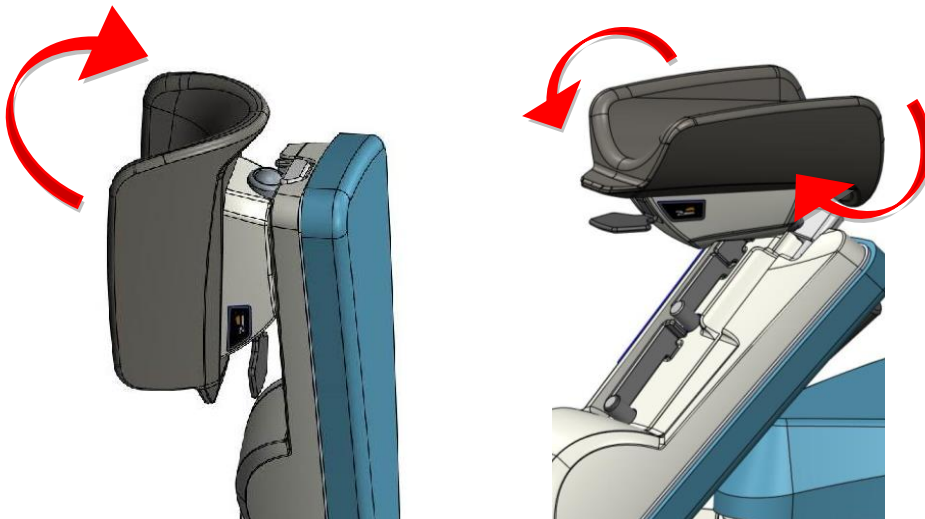



Warning:
Caution

Make sure that the footrest cups are handled correctly. Improper use of the footrests will damage the footrest upholstery (see Fig.1 and Fig. 2).



7.6.6 Leg rest tray height adjustment

Leg rest tray can be individually adjusted according to the physical proportions of the birth mother. To do so, the leg rest must be in "Gynaecological position". Then with one hand pull the control lever as on the picture below.

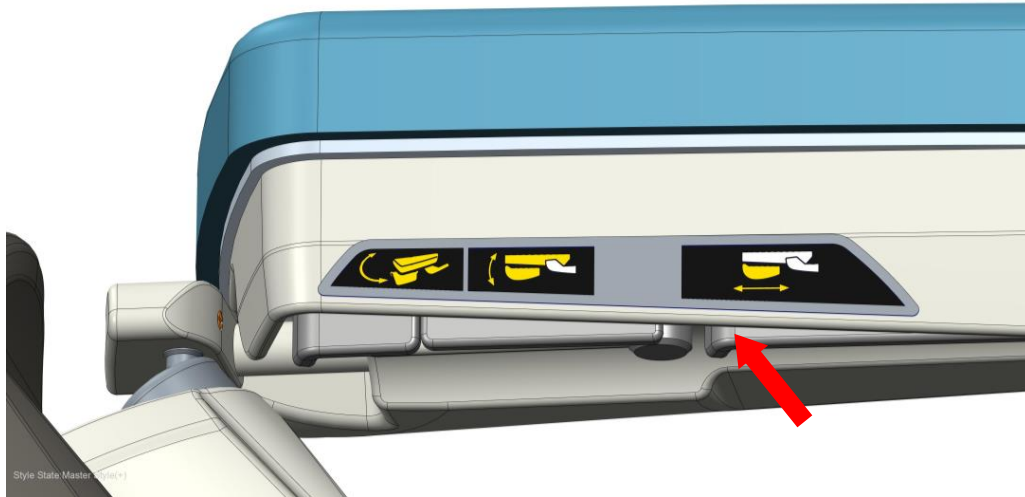

With the other hand adjust the leg rest tray in the desired height. Releasing the control lever locks the leg rest tray in the position. To reset the leg rest tray to its original height, repeat the procedure reversely.

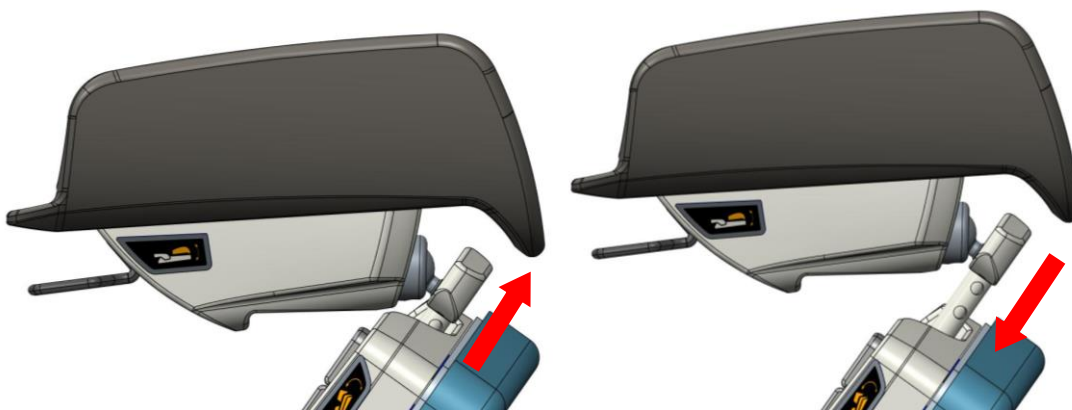

7.6.7 Leg straps

Fixing straps for legs are integral part of each foot rest to enable better support of flaccid muscles of the mother-to-be during the stages of birth.



Loosen the strap (1), place the mother's-to-be calf comfortably in the bowl of the foot rest (2) and fasten the strap (3).



7.7 Backup Battery



Warning: Dangerous electric voltage

The batteries may be only replaced by the appropriate service personnel!

The battery is intended solely for emergency power supply during power failures.

In case that the insufficiently trained personnel will perform the replacement of battery, the danger situation may occur or the functionality of medical device may be reduced.

Backup battery discharge is indicated by sound signal (1 s) after depressing any movement button. In this case, connect the bed to the mains immediately and charge the battery. The bed should not be used, when the battery has been completely discharged.

When the back-up battery is completely discharged, the recharging to the minimum level (allowing the use of this back-up battery again) will take at least one hour time. If you require the full charging of the battery, the necessary time for charging will take at least 24 hours!

The fully charged back-up battery will last in the stand-by mode for approximately 1 to 2 months (at the optimum temperature of 15 to 25°C). The allowed maximum temperature for the battery is 50°C!

The fully charged battery provides for the necessary functionality of the birthing bed (i.e. positioning of lift, tilting of the supporting systems, calling the nurse, and Trendelenburg), namely with minimum of four cycles, so that it will be possible to set the birthing bed into the basic safe position.

In case that the power supply of the bed will be interrupted, the "Call nurse" function will be usable for the time period of 1 to 2 months (provided that the positioning of the bed is not used!).

The birthing bed includes fully charged battery. The battery is automatically charged from the control unit and does not require special maintenance.

Indication of battery charging mode

Battery charging mode is indicated by a green indicator LED on side control panel.

Battery status indicator

Light on: battery disconnected or defective

Flashing: charging the battery

Light off: charging completed

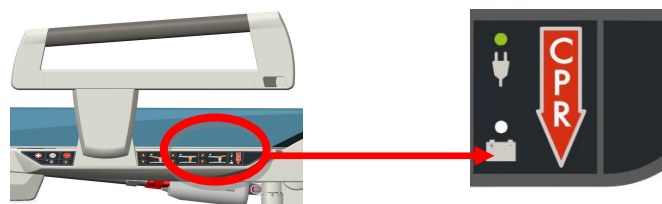

7.8 PPB-068 Grab handles, detachable (R/L)



Warning: Caution

When simultaneously using hand grips and setting the leg rests to the Foot rest position, collision may occur! Hence, it is necessary to pay attention to avoid injury of the personnel and/or the mother in labor when adjusting the leg rests.

The handles can be attached only in the position showed below, it is forbidden to fix them with the rubberized hold “downwards”.

The standard grab handles are designed as the detachable ones. For removal, the handles, drag the arresting element to unlock it and using your second hand, pull the handle out from its seat. For inserting, simply push-in the handle - the safety member will fix the handle in its appropriate position automatically.

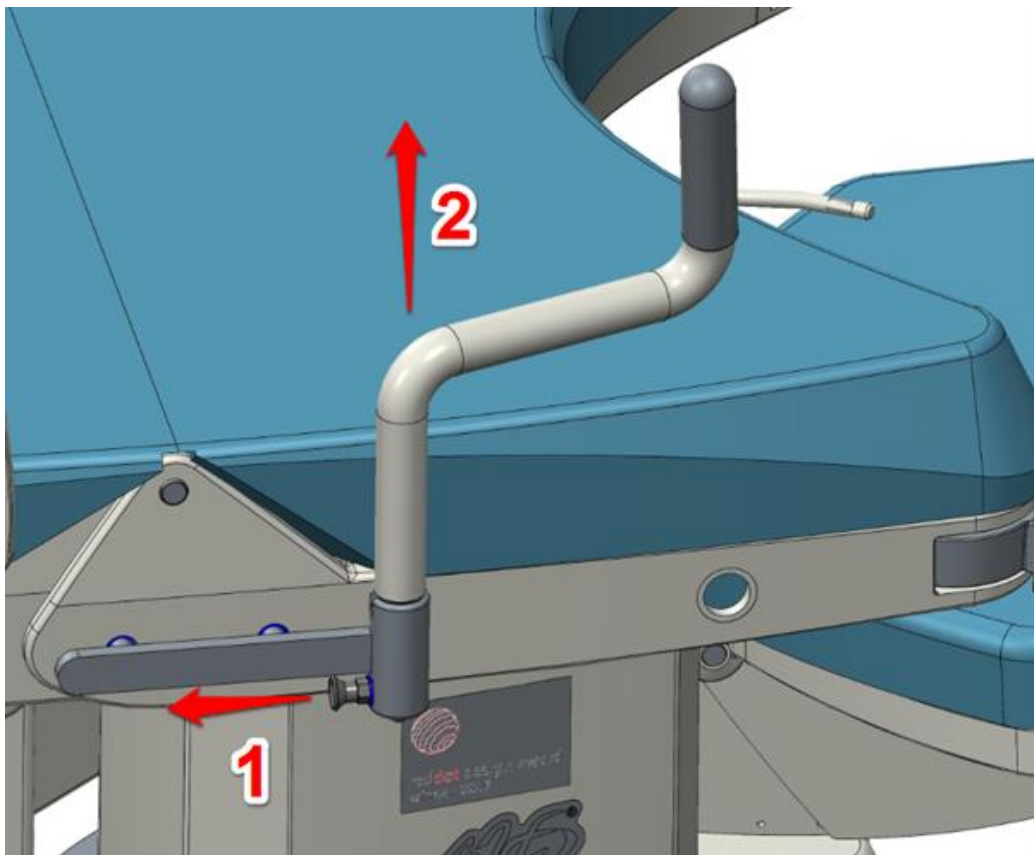

7.9 PPB-013 Grab handles, non-detachable, foldable (R/L)



Warning:
Caution

When simultaneously using hand grips and setting the leg rests to the Foot rest position, collision may occur! Hence, it is necessary to pay attention to avoid injury of the personnel and/or the mother in labor when adjusting the leg rests.

The optional grab handles (at extra costs) are designed as the non-detachable ones. These handles provide for "parking" and "active" positions. In order to position the handle into the "parking" position, press the safety member located on the side of the handle, and using your second hand, put the handle below the seating part of the bed. For inserting, simply pull-out the handle - the safety member will fix the handle in its appropriate position automatically.



7.10 Holder of infusion stand

Double-way undetachable infusion holder is used to fix the infusion stand.

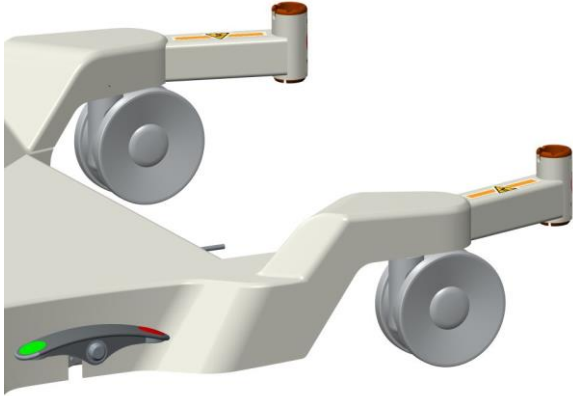

7.11 Equipotential coupling

The delivery bed is fitted with a coupling for synchronizing the potential with other electrical medical equipment. The coupling is located behind the bed under the lying surface of the bed. The bed is interconnected to the other device by means of a cable (not supplied with the bed) that is connected easily by its end to the coupling.

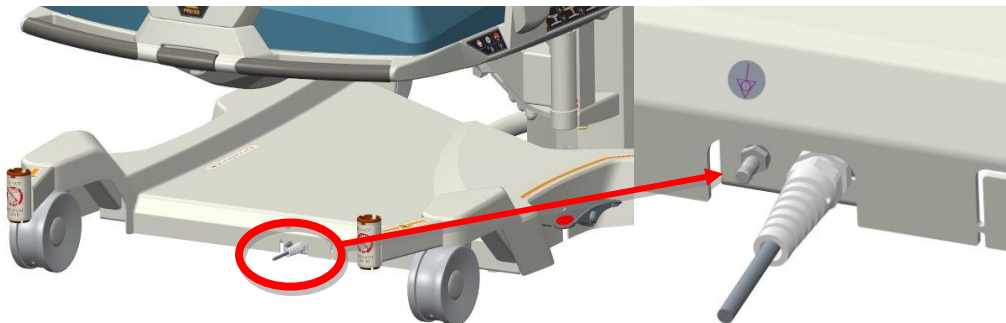

7.12 Exchangeability of the upholstery



Warning:
Caution

Incompatible upholstery can cause risk!

When changing the bed, always make sure that the upholstery fits correctly on the seat and back sections of the bed. Spaces filled with fabric do not fulfil their function, do not hold silicone pins of the upholstery and as such, pose a risk of injury of the labouring woman or damage to the plastic parts of the mattress.

The birth bed is fitted with replaceable upholstery. In case of damage to the upholstery (e.g. mechanical or physical-chemical damage), it is necessary to replace the upholstery for a perfect one in order to maintain the birth bed hygienic compatibility and overall safety. In other cases, the manufacturer recommends replacing the upholstery of bed surfaces after 5 years of use. Date of the upholstery manufacturing can be found on the reverse side of the back and foot sections.

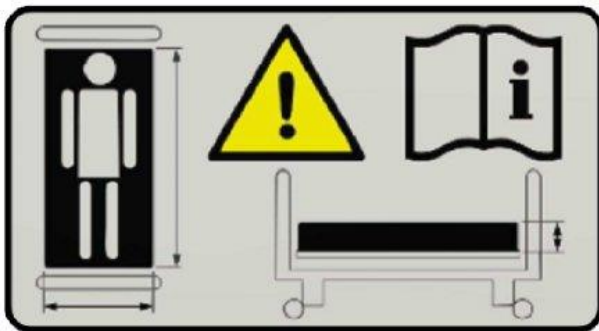

8 Accessories

8.1 PPB-062 Cable hand controller



Warning:
Caution

For safety reasons it is restricted to pass the hand controller cable under the birthing bed to reach the other side!

The operator may use the hand controller buttons to set the height position of the seat and back section inclination. The functions of the control buttons are shown in the picture below. Motoric setting is done by pushing and holding the desired function buttons.

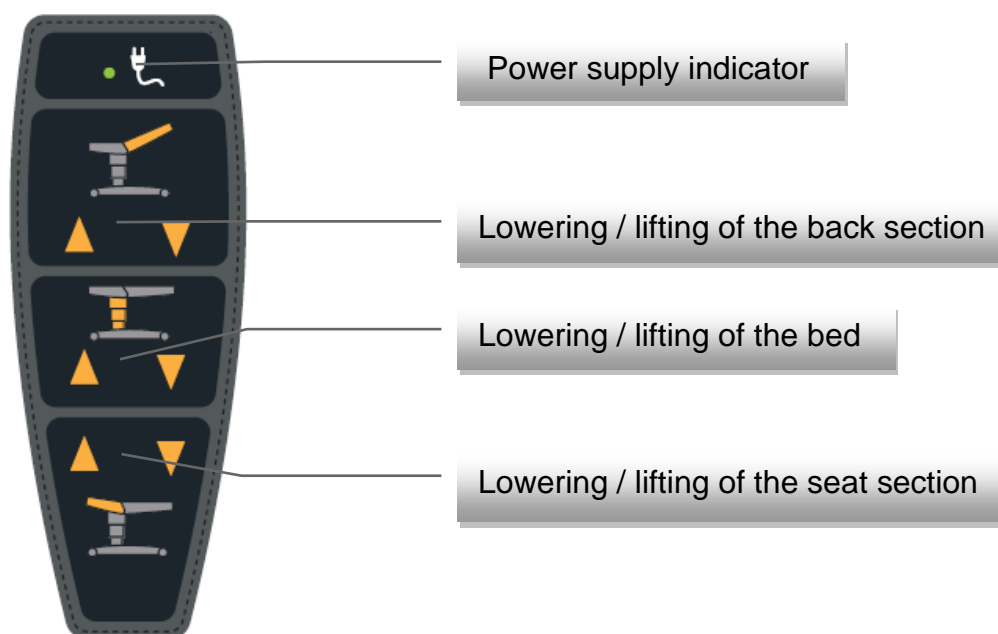

Recommended position of the manual control unit: only on the left side of the seat section, see picture.



8.2 PPB-071 Supporting bar



Warning:
Caution

Maximum weight load of the supporting bar is 70 kg in all direction (154 lb.).

Supporting bar is vertically locked up, it may be ejected from the holder in the upward direction!

After having pulled out the cross-bar, it is necessary to drag both arresting elements to unlock them.

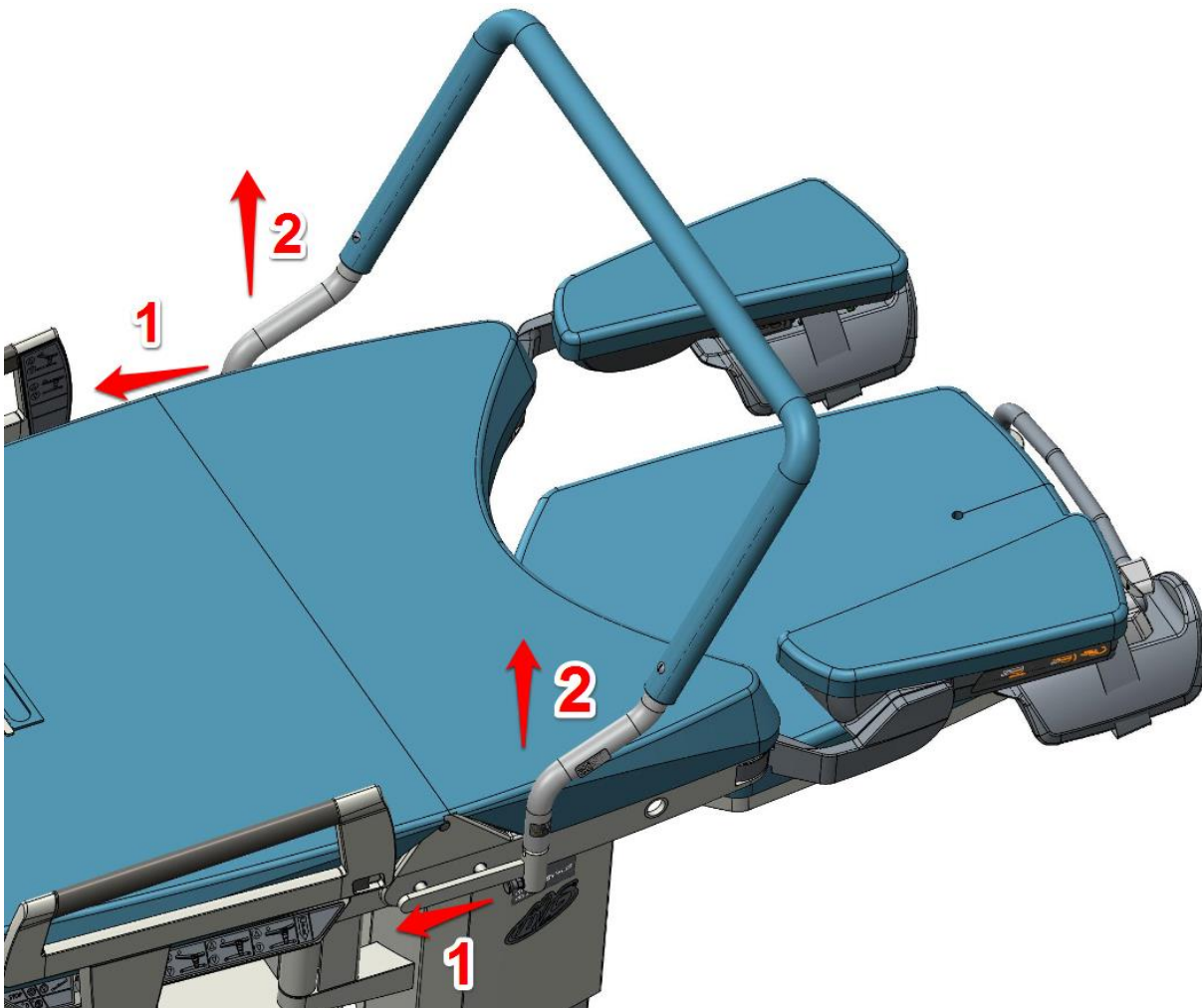

8.3 Under carriage light

The under carriage light is turned on by short pressing the button on the side control panel of the birthing bed. Repeated push of the button switches the lighting off.
Light is controlled by the personnel only.

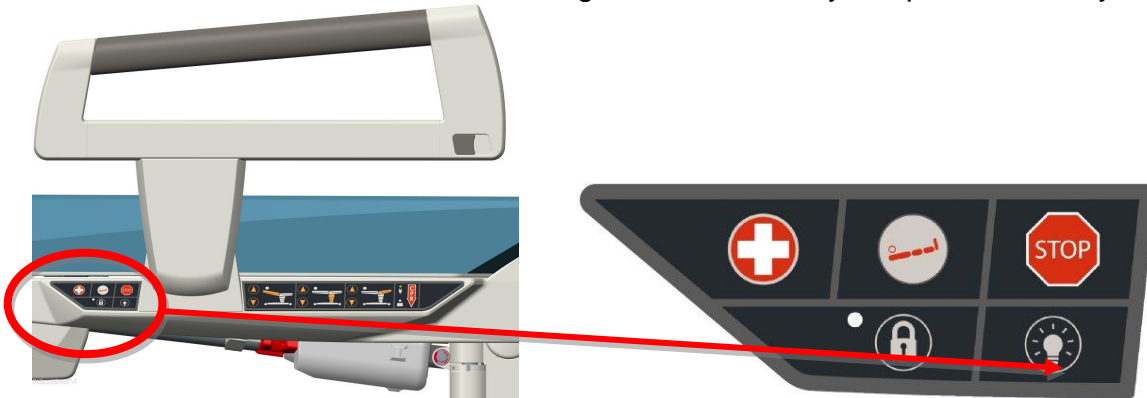

8.4 SB-B-00322 Infusion stand, stainless steel, telescopic



Warning:
Attention

Max. load-carrying capacity of one hook 2 kg!

Infusion stand is only used to hold infusion. It is restricted to use it for manipulation with birthing bed. It is also necessary to be cautious when manipulating with the bed in order to avoid the collision between the infusion stand holder or possibly the infusion stand and the other objects situated close to it.

8.5 PPB-064 Eurolath along the seat section



Warning:
Caution

Ensure that when the chair moves up and down, the surrounding objects do not collide or get caught with the Eurolath.

The eurolath is used for placing the given accessories, such as armrests, hand control, infusion stand.



8.6 PPB-060 Rear bed-head



Warning: Caution

To allow the anesthesiologist better access to the head of a birth mother, always remove the bed-head!

Bed-head is not intended for the suspension of a woman in labour by means of an auxiliary rope, bed sheet, or a towel!

Rear bed-head represents a safety element of the bed and can be used by the birth mother as a handle. The bed-head is automatically locked against movement. After pulling the security lever „PULL“, the bed head can be removed from the bed with the other hand.

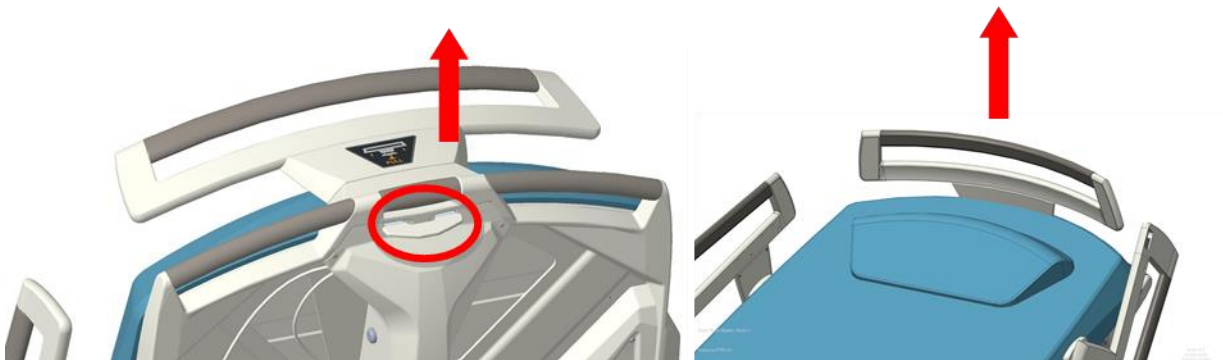

8.7 GKB-076 Doctor's chair (ergonomic)



8.8 ZK-05.X Doctor's chair



8.9 PPB-069 Front bumper on foot section



Warning:
Caution

Maximum weight capacity is 70 Kg (154 lb.).

Accessories can be attached to the holder and it serves as foot section protection as well. The set contains two side bumpers.

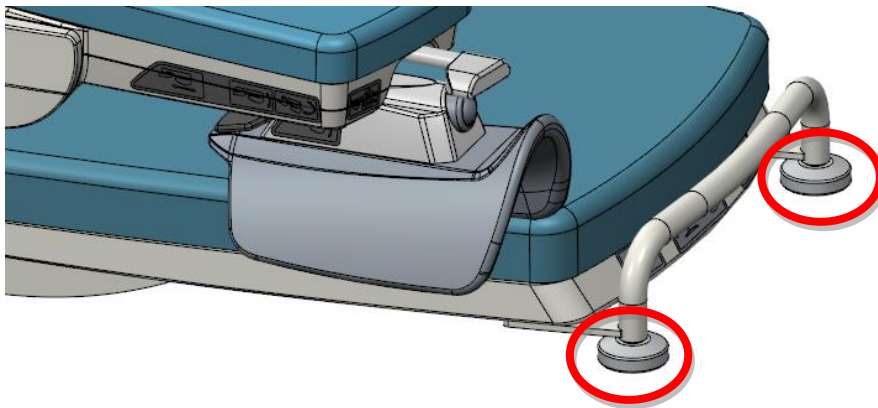

8.10 PPB – 066.01 Upper mattress (for 100 mm cushioning)

The accessory is primarily used after post-partum; it increases the comfort of the resting mother.



8.11 PPB – 070.01 Upper mattress (for 130 mm cushioning)

The accessory is primarily used after post-partum; it increases the comfort of the resting mother.



8.12 PPA-010 Tray on the swinging holder



Warning:
Caution

Tray may only be manipulated when the lying section of the foot rest section is adjusted in the low position!

The stainless steel tray is foldable on the swinging holder forth and backwards. It is possible to remove the tray from the holder in the forth position. Volume of the tray is 4,5 litres.

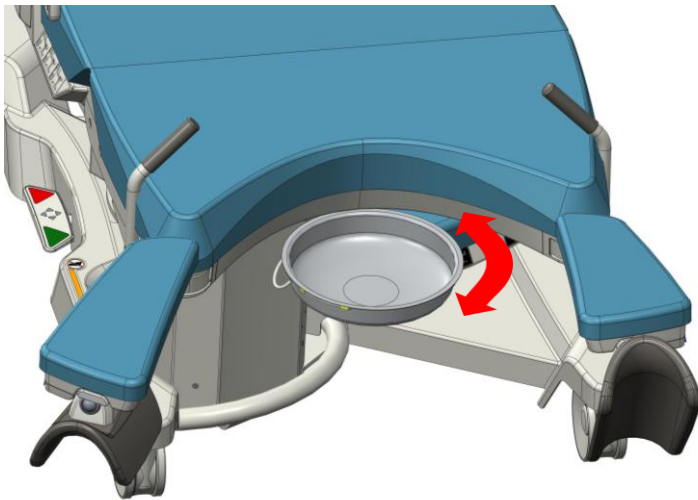

8.13 Nurse call



Warning: Caution

The control elements of the nurse call function cannot be deactivated!

If the power supply of the bed is disconnected, the Call nurse function can work for about 1 or 2 months (if the bed positioning is not used).

The nurse call button is located on the inner side of the side handle control panel (on the side of the labouring woman). After pressing and releasing the button an indicator light lights up, indicating that a nurse has been called.

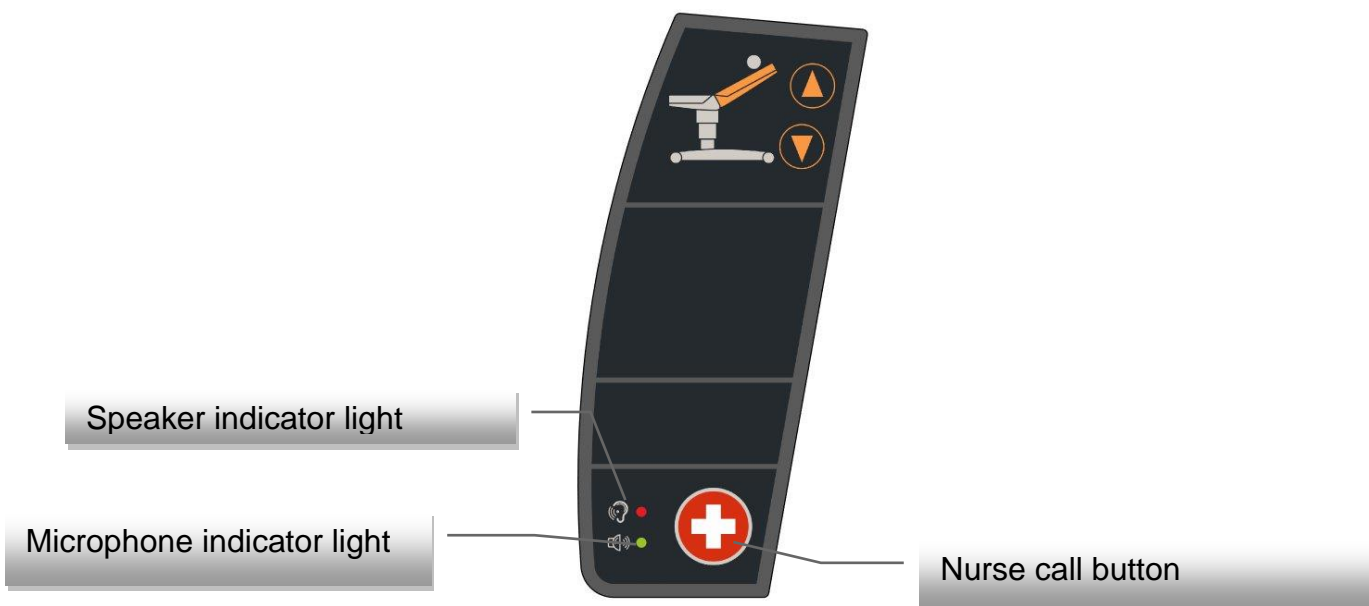

Subsequently, the labouring woman can speak into a microphone with a set of speakers located in the rear part of the handle.

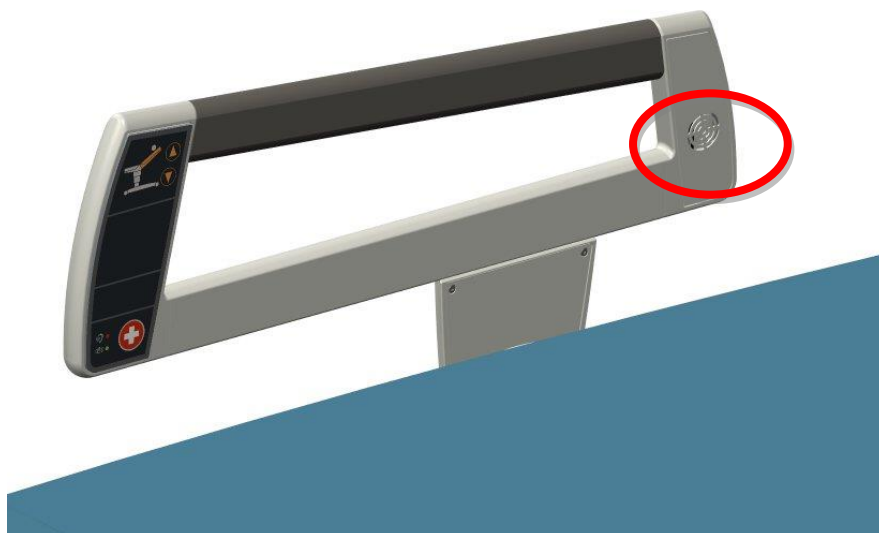

8.14 PPB-077 Front bumper fitted on the leg rest (R/L)



Warning:
Attention

Always park the leg holder trays before transport! Adjust the lowest position and move so that they do not overlap the contour of the leg rest.

Intended for hanging the accessories and, at the same time, leg rest protection.



8.15 Head rest

Comfort head rest can support the head of the woman in childbirth. Thanks to its ergonomics it can also serve to fill the lumbar part of the patient as to support her back, so that the spine maintains its natural curving. With lifted back section (sitting position), the head rest also helps smaller patients to achieve optimal position on the edge of seat section.

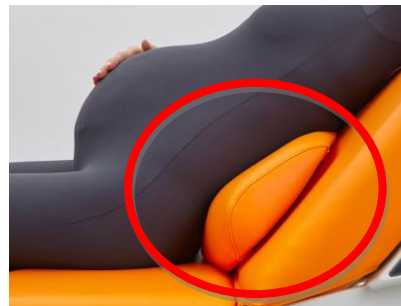

8.16 Bowl PPB-034

The bowl is made of stainless steel, with the capacity of 8 liters. The bowl cannot be shifted below the seat section (after giving birth, it is always recommended to remove it and park only the bowl holder).



8.17 DB-B-00194 Instrument tray

This flat, stainless-steel tray is in most cases used for tools necessary in post-delivery sutures. The tray can be parked below the seat section and, where required, you can place this tray onto existing and deeper trays (4,5l and 8l).



8.18 PPB-088 Protractor of the seat part, PPB-098 Protractor of the back part



Caution
Warning

The protractor is only for information

It is used to inform about the inclination of the back or the seat part of the delivery bed.

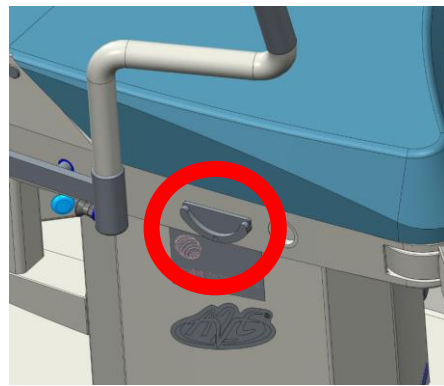
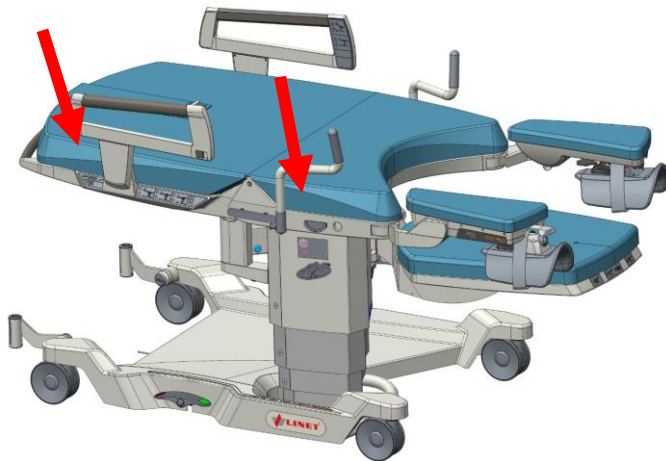

8.19 PPB-097 Bracket for oxygen bottles



Caution: Warning

Maximum load 10 kg (22 lb)!

The holder cannot be used on the bed on the right side of the DIN rail with respect to the patient sitting on the bed!

It can be used on the left side of the patient while sitting on the delivery bed. There is a risk of collision when positioning with the leg rest!

When positioning the delivery bed downwards, there is a risk of collision between the empty bracket and the oxygen bottle bracket with the foot / legs of the operating personnel. Risk of deterioration of the bed or injury to the patient, staff or a third party!

Do not step on the plastic frame cover when handling the bed with an oxygen bottle holder!

Before actively using the oxygen bottle holder, always check the correct dimensions of the oxygen cylinder, including the top of the bottle. Larger dimensions can collide with positioning bars!

When positioning the seat, the oxygen bottle holder also becomes mobile. Warning!

When using an oxygen cylinder, always check the patient's movements on the bed. There is a risk that the patient will cling to the oxygen bottle, thinking he has caught the sides of the bed! Risk of deterioration of the bed or injury to the patient, staff or a third party!

Never remove the holder and the oxygen bottle holder together

Installation procedure

Place the bracket on the right DIN rail in the direction of the green arrow. The bracket is designed so that it cannot be mounted on the opposite bracket (left DIN rail). Then insert the oxygen bottle vertically into the holder.

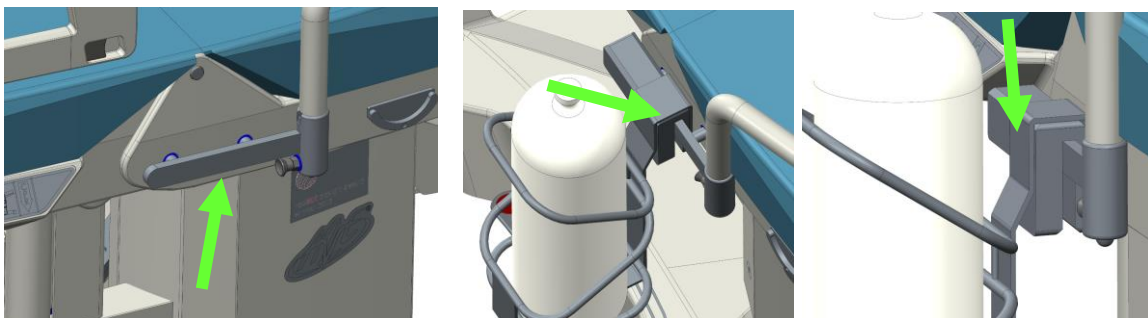

Contrary procedure

To remove the oxygen bottle holder, the procedure must be carried out in the reverse order to placement on the delivery bed.

8.20 S4-04642A Patient card



**Caution
Warning**

Condition of the order including the front bumper of the leg rest!

Snap only to the front bumper on the leg rest!

If the patient's card is hung in other places, such as the bed side or the headboard, there is a risk of instability. These parts of the bed are mobile! Therefore, we do not recommend hanging the patient card in these areas other than the front bumper on the leg rest!

Use to hang the patient card in A4 format.

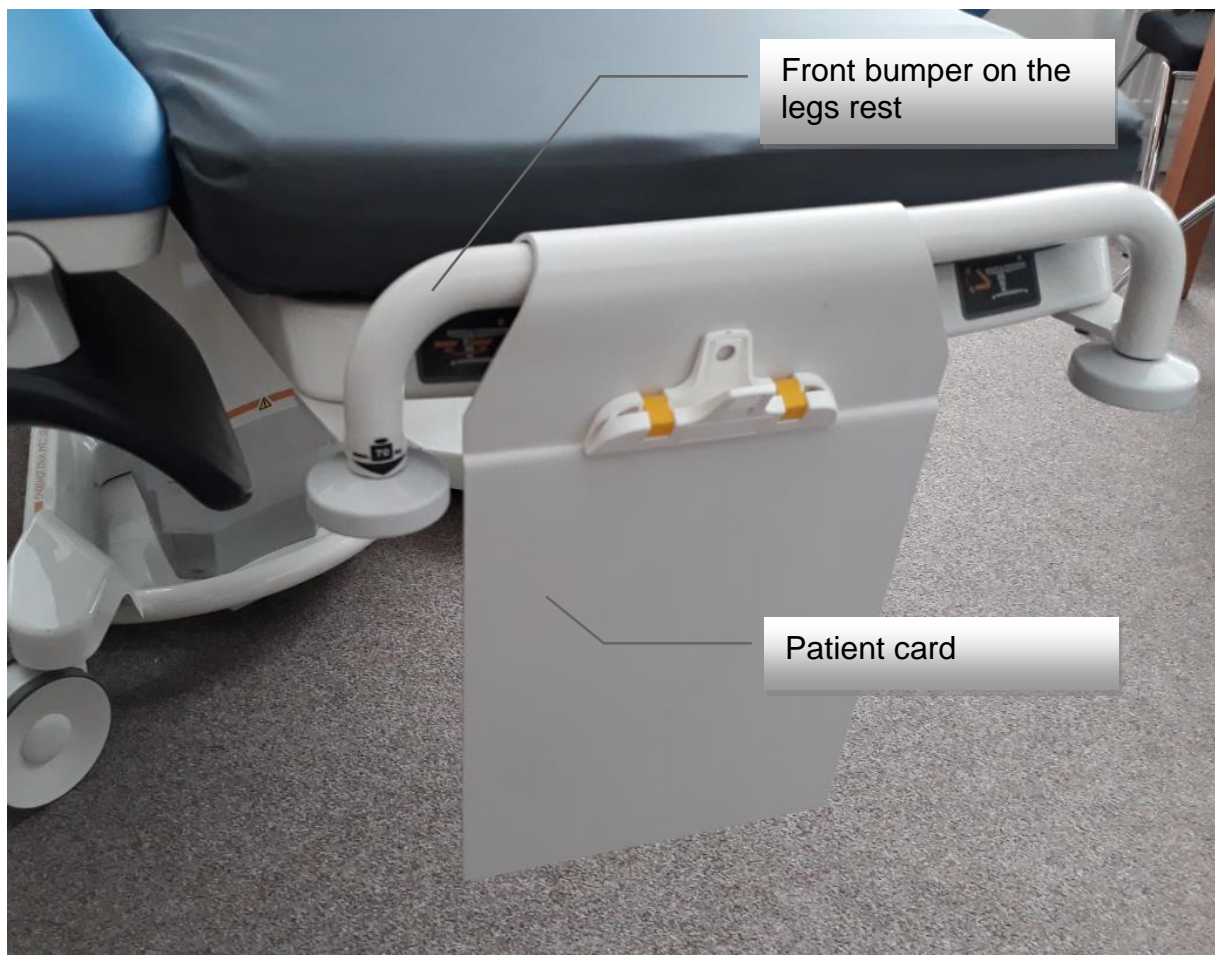

8.21 Baby plate



Caution Warning

The maximum load of the baby plate is 10 kg (22 lb)!

The Baby plate is a removable accessory!

When using the baby plate including when the new-born is placed there is always necessary that there is a permanent presence of staff!

It is absolutely forbidden to see staff moving away from the baby plate when the new-born is lying there!

The Baby plate can only be used by staff trained for this!

When mounting the baby plate on the bracket and after hearing the click, check by pulling towards you that the baby plate is correctly insured! The safety lever must be in the down position (safety position).

The Baby plate is not made for the transport of the new-born!

When installing the new-born on the baby plate, always do it on the longest part of the mattress! The installation of the new-born on the shorter part of the mattress may fall to the ground!

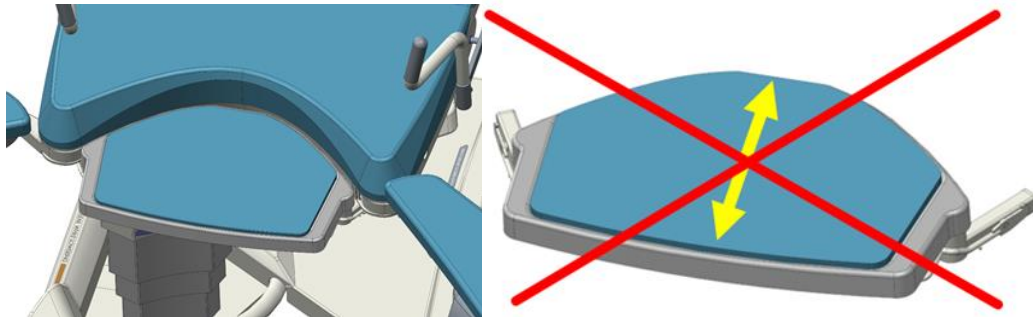

The baby plate moves with its seat, so that there is no distance between the genital matrix during childbirth and the surface of the baby plate. This must be considered!

The baby plate should not be installed upside down! The correct position of the baby plate before installation on the delivery bed is the one with the padding upwards.

Do not place the newborn on the baby plate without a mattress! Always use a mattress covered with the bed-linen provided by the hospital.

The baby plate cannot be used with a bowl and the foot section of the delivery bed. There is a risk of collision or damage to bed components or injury to the patient, staff or a third party! When using the baby plate, the revolving bowl and the leg rest cannot be used together.

The baby plate is used to drop the new-born for a short period of time. The umbilical cord is cut when the new-born is placed on the baby plate and then placed on the breast of his mother, or on another table to perform some necessary procedures. Then it can be used to expel the placenta and control it.

If the baby plate is not used it must be removed from the bed and stored in the room.

PPB-074 Version with mattress

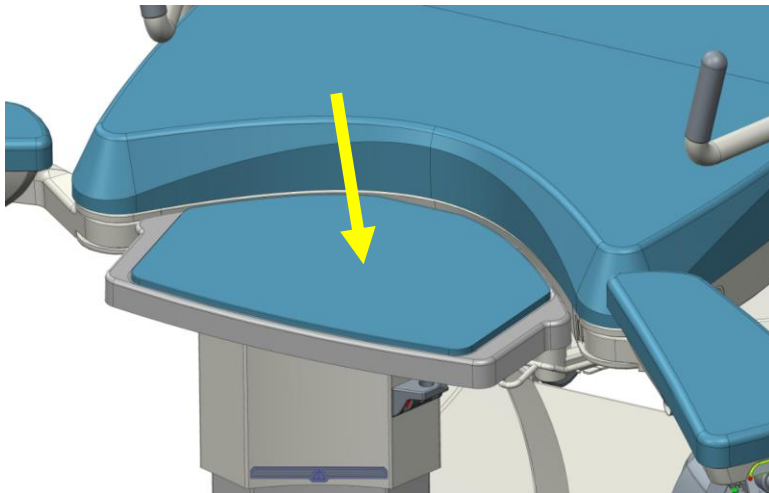

Procedure for mounting the baby plate on the delivery bed

When mounting the baby plate on the delivery bed, the locking levers must be moved to the unlocked position (in the direction of the green arrow). Then slide the baby plate by the handles in the seat part of the delivery bed and push it towards the seat part (1) until you hear a click (2)! Then make sure the lock lever is in the down position (2)

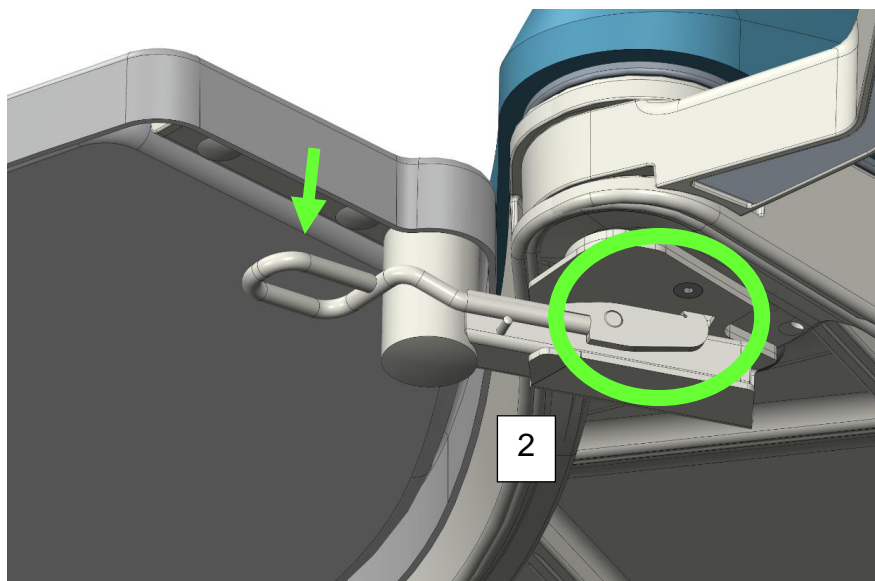
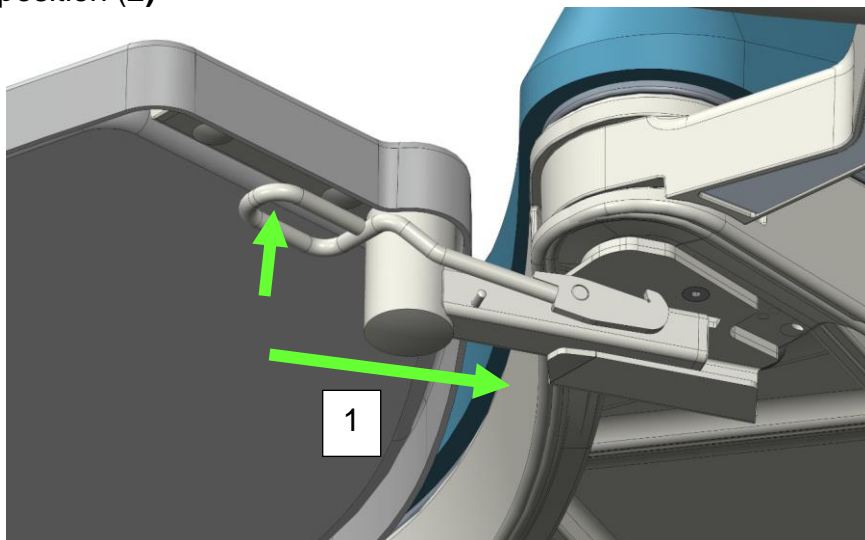

Procedure for dismounting the baby plate from the delivery bed

Remove the baby plate in the reverse order of installation. When removing the baby plate from the delivery bed, the locking levers must be moved to the unlocked position in the direction of the red arrow (1). Then slide the baby plate out of the handles on the seat part of the bed towards you. (2).

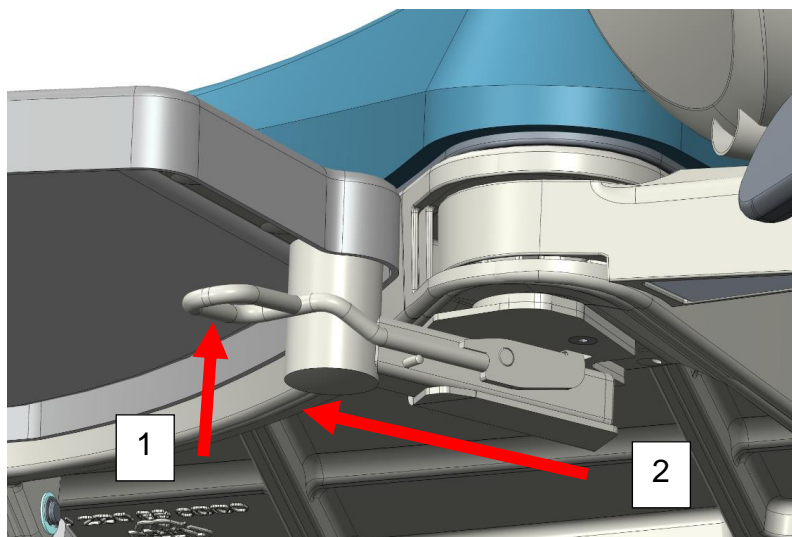

8.22 USB cell-phone recharger

The USB charger is used for charging cell phones and tablets
It is located on the back side of the back rest on the left side of the bed.
The USB connector has a plastic cover providing an IP protection for the USB connector.
When cleaning the bed, this cover needs to be closed to avoid water getting into the connector.

NOTE Maximum current for this device is 2 A.

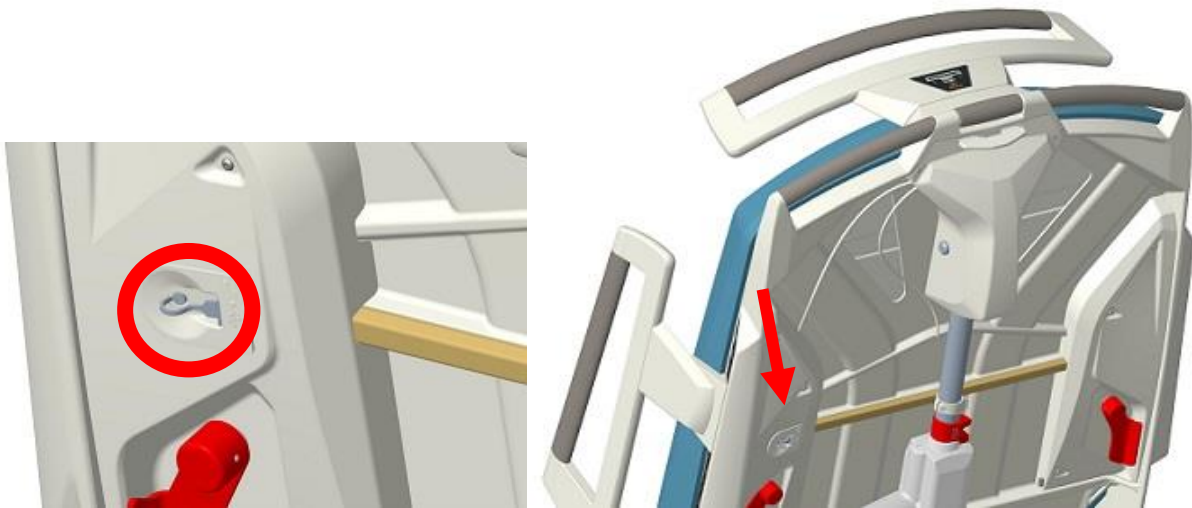

Caution:
Warning:

Risk of injury due to improper use!

Make sure that the accessories attached to the USB connector are intact
The user of the bed is responsible for meeting this requirement.



Caution:
Warning:

Risk of injury due to pinched power cord!

Make sure that the power cord of the attached accessories is not pinched by the siderail or the parts of the backrest section!
The user of the bed is responsible for meeting this requirement.



Caution:
Warning:

Risk of damage to property due to improper use!

Make sure that the attached accessories do not fall down!
The user of the bed is responsible for meeting this requirement.



Caution:
Warning:

Risk of damage to property due to improper use!

Never connect any heating element to the USB connector!

The user of the bed is responsible for meeting this requirement.

9 Care

All BORCAD Medical a.s. products are designed for many years of service under the conditions of correct use. Please use your bed and its accessories carefully. Please follow these instructions for use and recommended operation and maintenance instructions. Avoid negligent handling. Do not, in case of a function failure, undertake any repairs and never use force!

9.1 Cleaning and disinfection



Warning: Caution

Do not use any automated cleaning or disinfection methods!

For basic cleaning use a soft cloth and only a pH-neutral detergent solution of a multi-purpose cleaner.

For disinfection, we recommend using standard preparations for disinfection of surfaces based on for example quaternary ammonia compounds, peroxy-compounds. The dilution ratio recommended by the Manufacturer of these products must be followed at all times!

Do not use any abrasive washing aids or ketone based solvents.

By using too much cleaner you risk water leakage into the motor parts of the product, which may damage the electric wiring and render the product not functional.

In case of improperly performed cleaning and disinfection, there is a risk of nosocomial infection.

Put the upholstery on dry bed areas only.

When cleaning, place the footrest upholstery on the flat side.

This medical device with all its parts and accessories is not designed to undergo sterilization.

BORCAD Medical a.s. is not responsible for damage to the cushioning (e.g. cracking, paint flaking etc.), which would result from improper use of disinfectants. In such cases, warranty claim shall not apply.

According to the principles of good hygienic practice, the cleaning and disinfection of the delivery room, its equipment and all the medical devices used, must be made directly and promptly after the delivery (birth) in order to prepare the equipment for a new delivery. These principles apply also to the cleaning and disinfection of the delivery bed. All parts of the delivery bed must be cleaned. The procedure must be

verified and/or supplemented to be in compliance with the respective hospital guidelines, recommended hygiene rules and implemented procedures. After a bed has been used by a patient with infectious disease, the cleaning and disinfection of the bed must be done in accordance with valid and agreed hospital rules and implemented procedures. To reduce the risk of infection transmission, the pre-treated protective covering drapes and/or covering fabrics must be used, to avoid the contact of the skin of a woman in labour with the upholstery of the components of the delivery bed - seat, back, foot part and footrests.

9.1.1 Cleaning the bed

1. Supporting area including the head pillow starting from the head section toward the lower section;
2. Hangers and hand grips;
3. Side protections with integrated controls and hand switch;
4. Frame of the bed including integrated controls and rear panel;
5. Foot section and footrests as well as adjoining plastic elements;



6. Bottom side of the upholstery (lift up the upholstery);



7. Bed frame / supporting structure - completely from the head rest part to the sitting part;
8. Lift the chassis to the highest position, pull out the mains plug - remove the protective parts (right and left) and put them back in the original position after cleaning;
9. Lift the left chassis plastic cover and clean dirty areas.

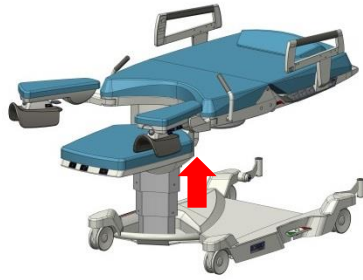

10. After lifting the left cover, you can lift the right plastic cover as well and clean the chassis. Make sure not to interfere with the electronics. After cleaning, first fit the right cover, then the left cover.

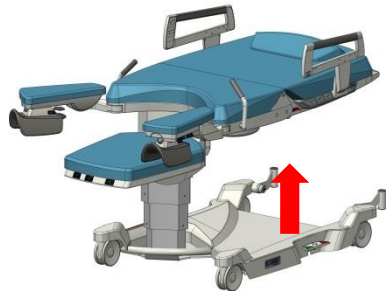

11. Infusion stand and holder;



12. Collecting tray (can be cleaned thermally, as stainless steel);



13. Casters and brake pedals.



9.1.2 Recommended disinfection (disinfectants for wiping)

RTU- Ready-to-use non-diluted products – spray or foam,		
Active substance	How to use	Example of disinfectant
Amine, Alcohol up to 30%	Spray and wipe	Incidin foam
Hydrogen Peroxide	Spray and wipe	Incidin OxyFoam S
Alcohol till 30%	Spray and wipe	Bacillol 30 Foam
Disinfection wipes		
QAS	Wipe	Sani cloth active
Hydrogen Peroxide	Wipe	Incidin OxyWipe S
Amine, Alcohol up to 30%	Wipe	Bacillol 30 tissues
Concentrated disinfectants, to be diluted		
Active substance	Concentration of the prepared solution of the disinfectant	Example of disinfectant
Glukoprotamine	0,5%	Incidin plus
Amine, QAS	0,5-1%	Terralin protect
Oxygen, QAS	1%	Desam OX
Oxygen, QAS	1%	Incidin Oxydes
Amine, QAS	0,5%	Incidin pro
Amine, QAS	0,5%	Surfanios premium
Oxygen	0,5%	Anios Oxy Floor
Oxygen	1%	Incidin Active
Oxygen	1%	Perform

Warning! Do not use disinfectants with active substance: alcohol over 30%, active chlorine, iodine, aldehydes.

9.1.3 How to properly coat bed with hospital bedding

The delivery bed must be protected against excessive dirt by a fabric covering! One of the options is using a covering from the operating room, the size of which corresponds to that of the relevant delivery bed section, or with a fabric coating used for standard beds. First of all, the lying section, back section or seat section will be covered, then the entire foot section and foot rests. We recommend covering exposed surfaces (seat section, foot rest) additionally with absorption gauze.



Other examples of correct coating of the bed using hospital coatings before labour are shown below.

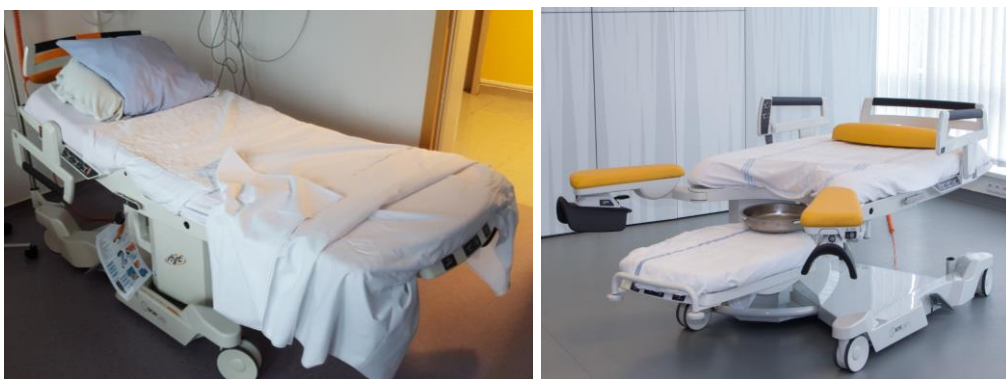

9.1.4 How to properly coat bed with Disposable bed sheets

Special-shape disposable coating materials, designed specifically for AVE2 birthing bed, can also be used. Swing out the back section of the mattress and put the coating on it. Then return the back section to its place, lift the seat section and put the coating on it as shown below.



Then coat the foot rests and the foot section. We recommend absorption pad be inserted between the back section and the foot section. The absorption pad can be easily renewed, where necessary.



9.1.5 How to properly coat bed with terrycloth

You can also use special-shape terrycloth set directly onto AVE2 birthing bed. Swing out the seat section of the mattress and put the coating on it. Return the seat section to its place and lift the back section. Put the coating on it as shown below.



Then coat foot rests and foot section.



10 Maintenance



Warning:
Caution

From practical testing results, the technical lifetime of the product is 15 years. Lifetime of the battery is limited and must be replaced.

- batteries (these are provided with the warranty of 6 months).
- gas springs need to be replaced every 12 years.
- the upholstery is guaranteed for 2 years.

Treads of fastening screws or the joints on the frame parts may get degreased by disinfectants. In these cases, timely lubrication prevents costly repairs.



Warning:
Dangerous electric voltage

Within the scope of annual regular revisions of a medical equipment, it is necessary to check the battery voltage (loadless). If the measured value is below 12V (24V in case of measuring two battery cells together), it is necessary to replace the battery immediately.

10.1 List of error, malfunction and generated messages

Problem description	Likely cause	Action to be taken by the operator to solve the problem	Actions to be taken by the qualified service personnel
The bed is not responding to controller commands.	The bed probably does not have electric supply and the battery is already depleted.	Plug the power supply cord to the electric socket (full recharge of the battery takes 8 hours).	Check, if the electric network is on and the socket in function. Use other electric socket.
The hand controller or some of its buttons are not working.	The hand controller cable is not properly inserted in the bed connector.	Make sure, the hand controller cable is inserted properly in the bed connector.	Check, if the bed responds with another hand controller. If so, replace the hand controller.
The function lock indicator is flashing and after pressing any button on the bed, a short alarm signal sounds	Emergency stop device is not working	Calling service	Replacing the DPS controlboard or erasing the error flag using 'r' sent via diagnostics
When all functions are actively locked, after pressing any button, a short acoustic signal sounds	Locked buttons	Unlocking buttons of keyboards by holding down the lock button	-
The bed emits intermittent acoustic signal and one of the controllers is not functioning	Controller failure	Call the service	Repair of the faulty controller

10.2 Technical parameters

Total length of the lying area (including the foot section)	2122 mm (83.54 inch)
Minimum length in the default setting (without the foot section)	1570 mm (61.81inch)
Full width with the side rails in active position	980 mm (38.58 inch)
Full width with the side rails in parked position	960 mm (37.79 inch)
Maximum height of the seat section (Trendelenburg 40°)	1143 mm (45 inch)
Upholstery width (maximum)	890 mm (35.04 inch)
Upholstery length (maximum)	2050 mm (80.71 inch)
Castor size	150 mm (5.91 inch)
Height of the supporting area including upholstery (seat section)	
Minimum	600 mm + 20mm (23.62 inch + 0,78 inch)
Maximum	1050 mm + 20mm (41.34 inch + 0,78 inch)
Vertical lift	450 mm (17.72 inch)
Vertical speed up (with max patient load)	11,25 mm/s (0,44 inch/s)
Vertical speed down (with max patient load)	20,45 mm/s (0,81 inch/s)
Upholstery thickness:	
Foot section	65mm (2.56 inch)
Back section	100/130mm (3.93/5.11 inch)
Seat section	100/130mm (3.93/5.11 inch)
Adjustment angles:	
Back section positioning angle	-10°/+70°
Seat section positioning angle	0°/+18,5°
Trendelenburg position	-10°
Leg rests vertical adjustment angle	0°/+143°
Leg rests horizontal adjustment angle	+60°
Foot section adjustment angle	0°-22°
Stickers, labels material	polymeric PVC foil
Maximum patient load	240 kg (529 lb.)
Safe working load	255 kg (562 lb.)
Overall product weight without accessories	245 kg (540 lb.)
Overall weight of the upper part of the birthing bed including accessories	140 kg (308 lb.)
Overall weight of the lower part of the birthing bed including accessories	96 kg (211 lb.)
Permitted back section load (125 mm from the edge)	150 kg (330 lb.)
Permitted foot section load (125 mm from the edge)	150 kg (330 lb.)
Permitted leg rest load	70 kg (154 lb.)
Permitted load of side rail	75 kg (165 lb.) vertical press
Permitted load of supporting bar	70 kg (154 lb.)
Weight of mattress (back and seat section 100/130mm, 2.56-5.11 inch)	8,6-9,6 kg (19-21 lb)
Weight of mattress (foot section)	1,2 kg (2,64 lb)
Weight of mattress (pair of leg rest)	2,6 kg (5,73 lb)
Noise level	Less than 65 dB (A)

10.3 Electrical parameters

Batteries – back-up	24V/2,3 Ah
Voltage – input	220-240 VAC
Voltage – input	110-120VAC
Voltage – input	100 VAC
Voltage – input	127 VAC
Frequency	50/60 Hz
Nominal value of the fuse in the control unit (220-240V)	T 3,15 AL, 250V
Nominal value of the fuse in the control unit (100V)	T 6,3AL, 250V
Nominal value of the fuse in the control unit (110-120V)	T 6,3AL, 250V
Nominal value of the fuse in the control unit (127V)	T 6,3AL, 250V
Maximum input	570 VA
Motor voltage	24 V
Ingress protection of the birthing bed	IPX4
Device class	I.
Classification of applied parts	B
All possibilities of voltage – input	100 VAC 50/60 Hz 110-120 VAC 50/60 Hz 127 VAC 50/60 Hz 220-240 VAC 50/60 Hz

Functional description of motors:

The birthing bed is fitted with electrical linear motors for moving the back section, seat section and for bed height adjustment. These motors require no maintenance.

10.4 Attached parts of product

The attached parts on the product are classified as Type B - they provide basic protection of the patient and comply with the applicable requirements of ČSN EN 60601-1 ed. 2:2007, by which they meet the requirements on classification of Type B attached parts.



10.5 Transport instruction, Storage instruction

Packed birthing beds may be exposed to conditions not exceeding the following limits for the period of up to 15 weeks:

Operation: 10°C – 40°C, 30% – 75%, 795 hPa – 1060 hPa

Storage and Transport: -10°C – 50°C, 20% – 90% (non-condensing),
795 hPa – 1060 hPa

10.6 Service and repairs



Warning: Caution

All service revisions, safety and technical inspections or service interventions must be executed only by a technician trained by BORCAD Medical a.s. company.

Diagrams, lists of product parts, descriptions or other information intended to help the service personnel with the repair of product parts, repairable by the service personnel only as implied by the manufacturer, are available upon demand at the manufacturer.

The product is provided with the warranty period of 2 years on conditions that regular annual service inspections are carried out.

For all medical equipment produced by the BORCAD Medical a.s. company, the operator must ensure regular technical safety inspections according to the Manufacturer's recommendation, thus the inspections must take place at least 1x per year or after the carrying out of any repair of the medical equipment or after any intervention regarding the electrical system of the medical equipment. The details about the scope, parameters and procedures of the technical safety inspection are specified in the service manual of the medical equipment.

In case the product is not functioning, please contact the product dealer in your country. In case of any other problems, please contact (preferably in English) the manufacturer at:

BORCAD Medical a.s.

Fryčovice 673
739 45 Fryčovice
Czech Republic

Tel: 736 628 231
Fax: 558 668 087

e-mail: service@borcadmedical.com

For repairs, please use only the original BORCAD Medical a.s. spare parts and the services of trained service technicians licensed to repair products of this type. Unprofessional repairs shall be considered as a substantial breach of the warranty terms and conditions and the manufacturer simultaneously does not bear any responsibility for any further possible damage to the product which might result from unprofessional intervention.

11 Environmental protection and liquidation of the product

Company BORCAD Medical a.s. is aware of the important role that the protection of the environment plays for future generations. Therefore, it focuses closely on the development, innovation and production of such technologies and materials that preserve the environment. BORCAD Medical a.s. complies with the EU directive on limiting usage of certain hazardous substances in electric, as well as electrical products.

The materials of this product are environmentally friendly. It does not contain hazardous substances on the basis of cadmium, mercury, asbestos, PCB or CFC. Noise emissions of the product meet the requirements on the protection of public health against harmful effects of noise and vibrations inside protected buildings.

All waste material after the installation of the product in operation is marked in accordance with the respective valid regulations on packaging material. After installing the product, BORCAD Medical a.s. company sorts out the packaging material according to corresponding pictograms and disposes of it by means of an authorized waste material disposing entity. For the free-of-charge waste material take back, please contact BORCAD Medical a.s. sales representative or service technician. Sort out the packaging waste material after putting the product in operation in accordance with the pictograms and deliver it to an authorised person for further use.

The product consists of recyclable steel, plastic and electronic components. For the purposes of optimum recycling, sort out the individual parts of the product when the lifetime of the product comes to an end in a way so that they might be further used as material from which the product had been manufactured (see diagrams below).



Acu / battery

Accumulators can be disposed of by a local waste material disposal system. Carry out the disposal of the material in accordance with local waste material regulations (expert personnel, assistance obligatory). Before disposal clean and disinfect the product properly. By proper disposal of the product, you will help to preserve precious natural resources and prevent potential negative effects on the environment and human health, which may result from improper disposal of waste materials. For more details please contact competent environmental authorities, or the nearest disposal hub for recycled waste material.

12 List of available equipment

N (Basic versions):

PPB-AX Birthing bed AVE2:
Standard leg rests + leg straps (pair)
Backup battery
Sliding foot section including the upholstery
Seamless mattress
Manual CPR
Infusion stand holder on both sides of the bed
Side rail with controls
Fixed panel with controls
Handgrifts (pair)
Castors 150mm, 1 x directional
Central brake
Equipotential busbar
Network cable of one's choice
Choice from standard color options
Packaging

B (Power cable):

PPB-050.37	Electric cable JAR - spiral, 4m, orange
PPB-050.30	Electric wire IZR - straight, 3,5m, orange
PPB-050.31	Electric cable EU - spiral, 4m, orange
PPB-050.32	Electric cable USA - straight, 4m, orange
PPB-050.33	Electric wire CH - spiral, 4m, orange
PPB-050.35	Electric cable UK - spiral, 4m, orange
PPB-050.40	Electric cable ITA - spiral, 4m, orange
PPB-050.38	Electric cable AUS - spiral, 4m, orange
PPB-050.39	Electric cable BRA - straight, 4m, black
PPB-050.36	Electric cable ITA - spiral, angled, 4m, orange

N (Electrical system):

PPB-050.21	220-240 VAC - Electric equipment
PPB-050.22	110-120 VAC - Electric equipment
PPB-050.23	100 VAC - Electric equipment
PPB-050.24	127 VAC - Electric equipment

N (Mattress thickness):

PPB-014-X	100 mm
PPB-080-X	130 mm
PPB-083-X	100 mm with a zipper
PPB-081-X	130 mm with a zipper

A (Color):

A Violet F4340-50621
B Blue F4340_07459
F Green F4340-20157
M Yellow F4340_07477
P Orange F4340_20127
X3 Own choice of leatherette

F4340_00002 F4340_00002
F4340_07422 F4340_07422
F4340_07432 F4340_07432
F4340_07436 F4340_07436
F4340_07445 F4340_07445
F4340_07476 F4340_07476
F4340_07478 F4340_07478
F4340_07479 F4340_07479
F4340_07480 F4340_07480
F4340_07485 F4340_07485
F4340_07496 F4340_07496
F4340_10120 F4340_10120
F4340_10295 F4340_10295
F4340_20129 F4340_20129
F4340_20130 F4340_20130
F4340-5015 F4340-5015
F4340-5347 F4340-5347
F4340-20150 F4340-20150
F4340-20154 F4340-20154
F4340-20156 F4340-20156
F4340-20161 F4340-20161
F4340-20162 F4340-20162
F4340-50454 F4340-50454
F4340-50618 F4340-50618
F4340-50619 F4340-50619
F4340-50620 F4340-50620
F4340-50622 F4340-50622
F4340-50623 F4340-50623
T Pink F4340-20149

N (Upholstery):

PPB-006.07-X PPB-006.07 Upholstery of the footrest
PPB-007.03-X PPB-007.03 Upholstery of the right leg holder
PPB-008.03-X PPB-008.03 Upholstery of the left leg holder

N (Nurse Call)

PPB-046 Nurse Call
PPB-047 NO Nurse Call

N (Footrest)

- PPB-076 Set of leg rests (US)
- PPB-075 Set of leg rests (outside US)

N (Stickers)

- PPB-030.05 Sticker BORCAD Medical
- PPB-YXZ0 Nameplate BORCAD Medical
- PPB-030.80 Warning stickers

N (Mandatory selection)

- PPB-067-X Supporting bar
- PPB-062 Hand controller
- PPB-064 Eurobar
- PPB-065 Without eurolath
- PPB-070.01 Overlay for 100 mm mattress
- PPB-066.01 Overlay for 130 mm mattress
- PPB-060 With Headboard
- PPB061 With covers of Heaboard

N (Packaging)

- PPB-090 Cartonbox on palette with indicator
- PPB-091 Overseas packaging without indicator
- PPB-092 Reinforced cartonbox on palette with indicator
- PPB-093 Foil

N (Operational manuals)

- 84660 PPB-072-CZ
- 84664 PPB-072-DE
- 84666 PPB-072-EN
- 84668 PPB-072-ES
- 84670 PPB-072-FR
- 84672 PPB-072-IT
- 84678 PPB-072-SWE
- 87892 PPB-073-US
- 87795 PPB-072-NL
- 87894 PPB-073-CAN

N (Optional)

- PPB-069 Front holder of accessories
- GKB-076.X Doctor's chair - ergonomic
- PPA-36 Telescopic infusion stand
- ZK-05.X Doctor's chair
- PPA-33 Large stainless steel bowl - 10 l
- PPB-014.03-X3 Head rest

PPB-077 Front bumper fitted on the leg rest (R/L)
PPA-10 Sliding stainless catch basin 4.5l
PPB-CCC Under carriage light
PPB-012 Set of Hand Grips (removable)
PPB-013 Set of Hand Grips (foldable)

N (Overlays)

PPB-100-A Terry bed clothes – white

PPB-030.80 Warning stickers

832 Non-sterile absorbent non-permeable pad
874 STANDARD Non-sterile non-permeable supporting area cover
875 STANDARD Non-sterile non-permeable foot section cover
876 STANDARD Non-sterile permeable leg rest cover
877 COMFORT Non-sterile non-permeable supporting area cover
878 COMFORT Non-sterile non-permeable foot section cover
879 COMFORT Non-sterile permeable leg rest cover
PPA-10 Sliding stainless catch basin 4.5l
PPB-034 Stainless steel bowl - 8 l
PPB-009 Holder

N (Choosing castors)

PPB-078 Standard castors (150mm)
PPB-079 Castors with longer pin (150mm)